



CAUTION!

- Remove power to unit before wiring input and output connections.
- Follow instructions carefully to avoid personal injury.

Contents

1. Installation
2. Specifications
3. Electrical Connections
4. Menu Functions



1. Installation

ProcessPro transmitters are available in two styles: panel mount and field mount. The panel mount is supplied with the necessary hardware to install the transmitter. This manual includes complete panel mounting instructions.

Field mounting requires a separate mounting kit. The 3-8050 Universal kit enables the transmitter to be installed virtually anywhere. Detailed instructions for field installation options are included with the 3-8050 Universal kit.

1.1 Panel Installation

1. The panel mount transmitter is designed for installation using a 1/4 DIN Punch. For manual panel cutout, an adhesive template is provided as an installation guide. Recommended clearance on all sides between instruments is 1 inch.
2. Place gasket on instrument, and install in panel.
3. Slide mounting bracket over back of instrument until quick-clips snap into latches on side of instrument.
4. To remove, secure instrument temporarily with tape from front or grip from rear of instrument. **DO NOT RELEASE.** Press quick-clips outward and remove.

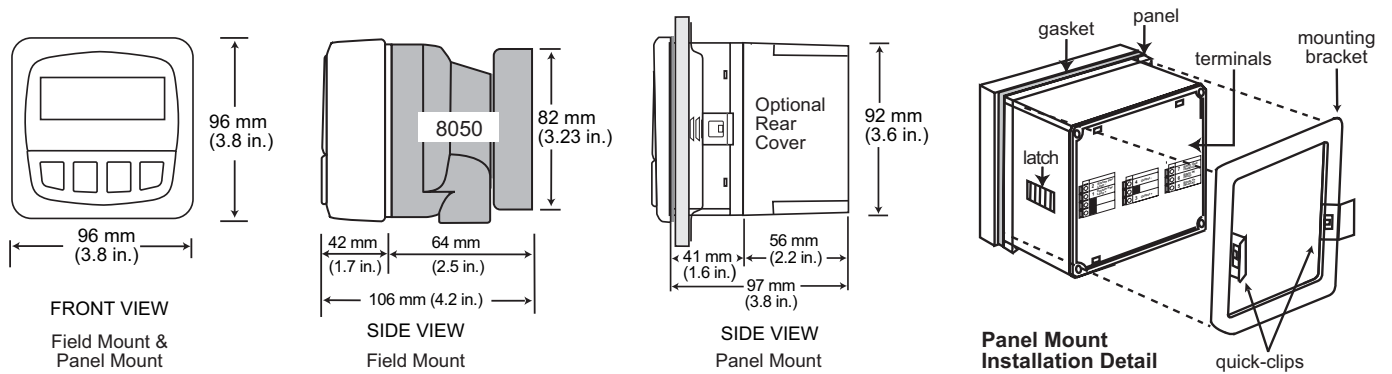

2. Specifications

General

Compatible sensors:

- Signet 2720 Twist-Lock Pre-amplifier and electrodes
- Signet 2760 Dry-Loc Pre-amplifier and electrodes

- Accuracy: ±0.03 pH, ±2 mV ORP

Enclosure:

- Rating: NEMA 4X/IP65 front
- Case: PBT
- Panel case gasket: Neoprene
- Window: Polyurethane coated polycarbonate
- Keypad: Sealed 4-key silicone rubber
- Weight: Approx. 325g (12 oz.)

Display:

- Alphanumeric 2 x 16 LCD
- Contrast: User selected, 5 levels
- Update rate: 1 second

Electrical

- Power: 12 to 24 VDC ±10%, regulated, 60 mA max.

Sensor input range:

- pH: 0.00 to 14.00 pH
- temp. (pH only) 3K Balco, -25 to 120°C (-13 to 248°F)
- ORP: -1000 to +2000 mV, isolated (10KΩ I.D. resistance T+, T-)

- Max loop impedance: 50 Ω max. @ 12 V
325 Ω max. @ 18 V
600 Ω max. @ 24 V

Update rate: 0.5 seconds

- Accuracy: ±0.03 mA @ 25°C, 24 V

Two Open-collector outputs:

- Isolated, 50 mA sink or source, 30 VDC max. pull-up voltage
- Programmable for:
 - Hi or Lo operation, w/adjustable hysteresis
 - Proportional pulse operation (400 pulses/minute maximum)

Environmental

- Operating temperature: -10 to 70°C (14 to 158°F)
- Storage temperature: -15 to 80°C (5 to 176°F)
- Relative humidity: 0 to 95%, non-condensing
- Maximum altitude: 2000 m (6562 ft)

Standards and Approvals

- CE, UL listed
- Immunity: EN50082-2
- Emissions: EN55011 Class B
- Manufactured under ISO 9001 and ISO 14001

3. Electrical Connections



Caution: Failure to fully open terminal jaws before removing wire may permanently damage instrument.

Wiring Procedure

1. Remove 0.5 - 0.625 in. (13-16 mm) of insulation from wire end.
2. Press the orange terminal lever downward with a small screwdriver to open terminal jaws.
3. Insert exposed (non-insulated) wire end in terminal hole until it bottoms out.
4. Release orange terminal lever to secure wire in place. Gently pull on each wire to ensure a good connection.



Wiring Removal Procedure

1. Press the orange terminal lever downward with a small screwdriver to open terminal jaws.
2. When fully open, remove wire from terminal.

Wiring Tips:

- Do not route sensor cable in conduit containing AC power wiring. Electrical noise may interfere with sensor signal.
- Routing sensor cable in grounded metal conduit will help prevent electrical noise and mechanical damage.
- Seal cable entry points to prevent moisture damage.
- Only one wire should be inserted into a terminal. Splice double wires outside the terminal.

Terminals 1-4: Passive current loop

12-24 VDC $\pm 10\%$ required for system power and current loop output.

Max. loop impedance:
 50 Ω max. @ 12 V
 325 Ω max. @ 18 V
 600 Ω max. @ 24 V

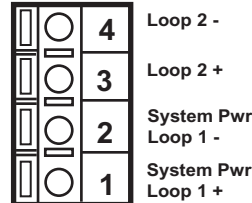

Terminals 13-16: Sensor connections

13-14 are mV (pH or ORP) input from the electrode.
 15-16 are Temperature input from the pH electrode or 10K id resistor from ORP electrode

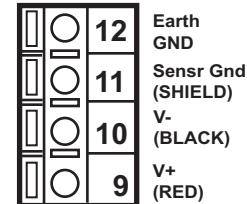
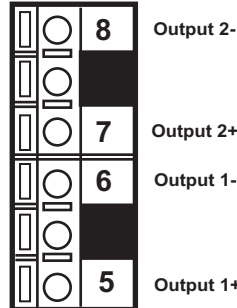
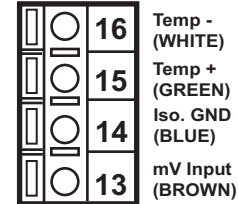

Internal open-collector circuit

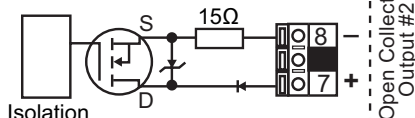

Internal open-collector circuit

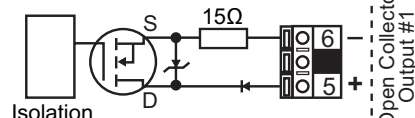

Terminals 9-12: Pre-amplifier power and grounds

9-10 are DC voltages from the 8750 to power the pre-amplifier.
 11-12 are ground terminals for the sensor and for earth ground.

Terminals 5-8: Open-collector Outputs

Two transistor outputs, programmable in CALIBRATE menu as:

- High or Low setpoint with adjustable hysteresis
- Proportional pulse up to 400 pulses per minute
- May be disabled (Off) if not used.

3.1 Sensor Input Connections

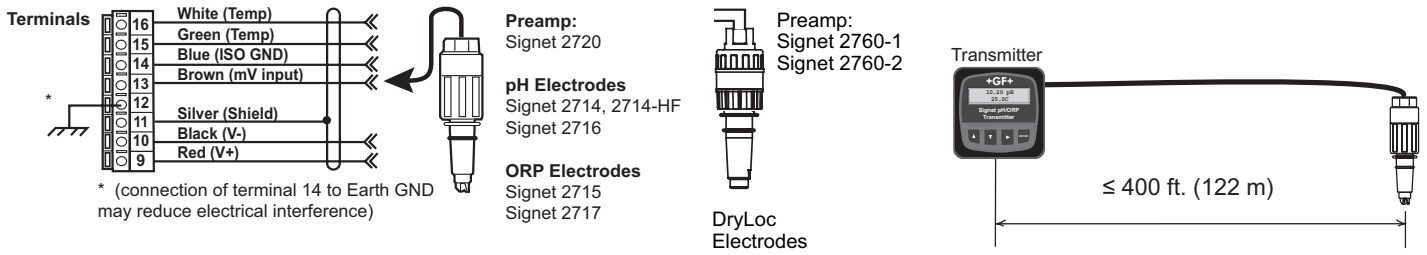

3.2 System Power/Loop Connections

Stand-alone application, no current loop used

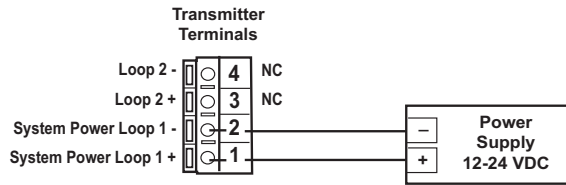

Connection to a PLC/Recorder separate supply

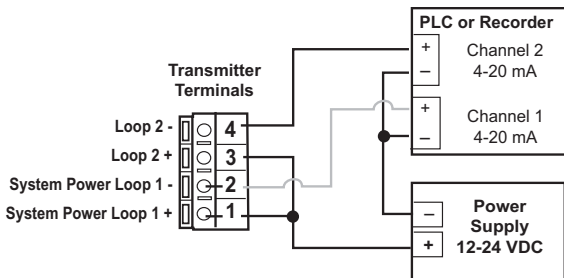

The current loop is a passive circuit.
12-24 VDC must be provided from an external source.

Connection to a PLC with built-in power supply

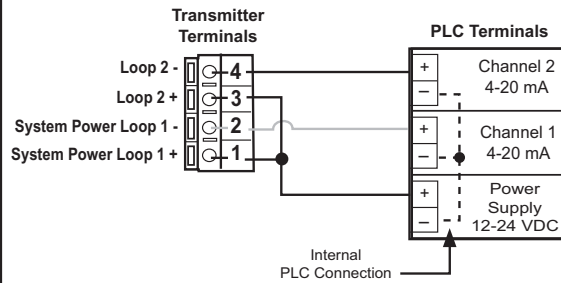

Example: Two transmitters connected to PLC/Recorder with separate power supply

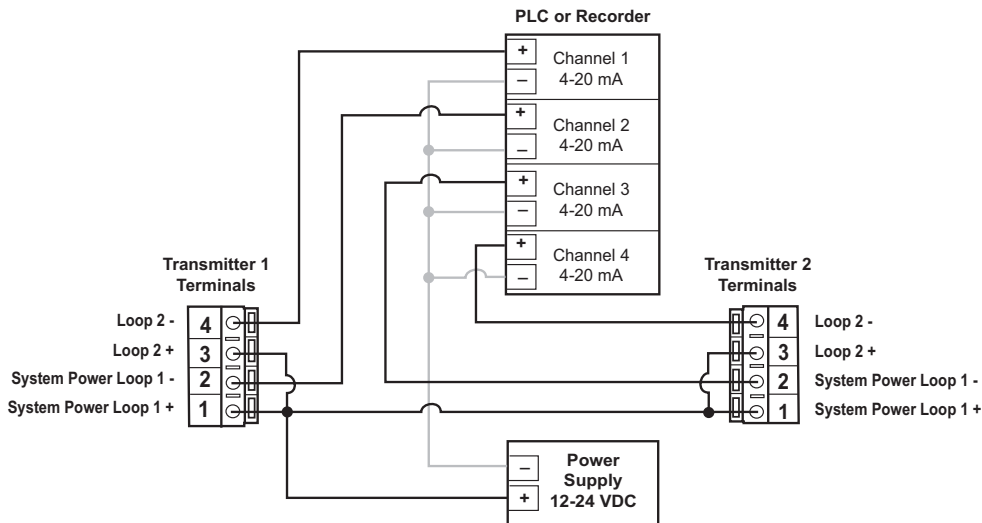

3.3 Open Collector Output

The Open Collector output can be used as a switch that responds when the process value moves above or below a setpoint, or it can be used to generate a pulsing signal with a rate proportional to the process value.



- **Low:**

Output triggers when process variable is less than the setpoint. The output will relax when the process moves above the setpoint plus the hysteresis value.

- **High:**

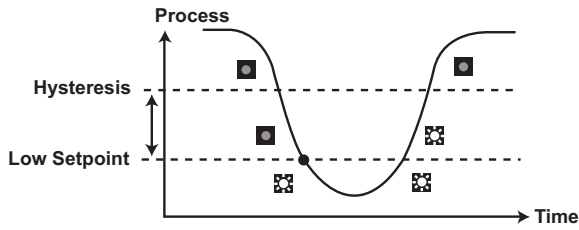
Output triggers when process variable is greater than the setpoint. The output will relax when the process variable moves below the setpoint plus the hysteresis value.



Relay energized 
Relay relaxed 

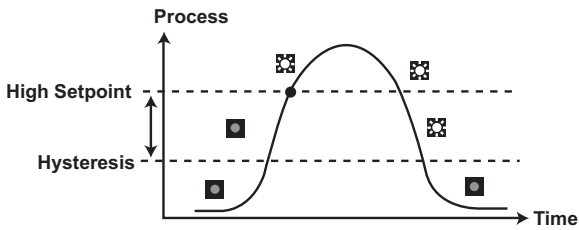

- **Proportional Pulsing**

The Open Collector output will generate a 100 mS pulse at the rate defined by settings in the CALIBRATE menu (see page 6)

In the example below:

- The output will be 0 pulses/min. at pH values less than 5.0.
- The output will be 50 pulses/min. at 7.5 pH.
- The output will be 100 pulses/min. at pH values above 10 pH.

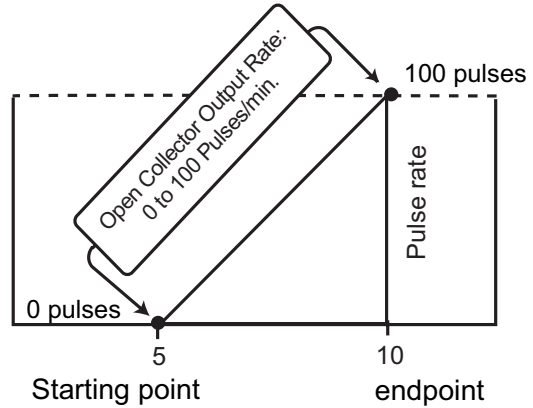

VIEW Menu

- During normal operation, ProcessPro displays the VIEW menu.
- When using the CALIBRATE or OPTIONS menus, ProcessPro will return to the VIEW menu if no activity occurs for 10 minutes.
- To select the item you want displayed, press the UP or DOWN arrow keys. The items will scroll in a continuous loop. Changing the display selection does not interrupt system operations.
- No key code is necessary to change display selection.
- Output settings cannot be edited from the VIEW menu.



View Menu for pH

| Display | Description |
|--------------------|---|
| 7.00 pH 12.6 °C | Monitor the Temperature input from the sensor. This is the permanent display. |

All of the VIEW displays below are temporary. The permanent display will return after ten minutes.

| | |
|------------------|--|
| Input: 307 mV | Monitor the millivolt input from the electrode. Use this display to determine the relative condition of your electrode during periodic calibration. (7 pH buffer = 0 mV, ±50 mV) |
|------------------|--|

| | |
|---------------------------|----------------------------------|
| Loop1 Output: 14.16 mA | Monitor the 4-20 mA Loop output. |
|---------------------------|----------------------------------|

| | |
|-------------------------|---|
| Last CAL: 04-20-07 > | Monitor date for scheduled maintenance or date of last calibration. (See description in Calibrate Menus.) |
|-------------------------|---|

| | |
|---------------------|--|
| EASY CAL: CAL: > | Easy Cal is the fastest and simplest periodic calibration method. Requires 4 pH, 7 pH and 10 pH. (Any two) |
|---------------------|--|

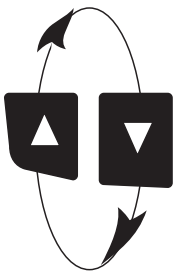

ProcessPro Editing Procedure:

Step 1. Press and hold ENTER key:

- 2 seconds to select the CALIBRATE menu
- 5 seconds to select the OPTIONS menu.

Step 2. The Key Code is UP-UP-UP-DOWN keys in sequence.

- After entering the Key Code, the display will show the first item in the selected menu.

Step 3. Scroll menu with UP or DOWN arrow keys.

Step 4. Press RIGHT ARROW key to select menu item to be edited.

- The first display element will begin flashing.

Step 5. Press UP or DOWN keys to edit the flashing element.

- RIGHT ARROW key advances the flashing element.

Step 6. Press ENTER key to save the new setting and return to Step 3.

Notes on Step 1:

- The View Menu is normally displayed.
- The CALIBRATE and OPTIONS menus require a KEY CODE.

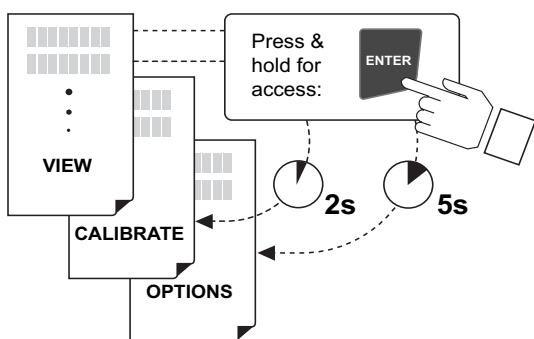

Notes on Step 2:

If no key is pressed for 5 minutes while display is showing "Enter Key Code", the display will return to the VIEW menu.

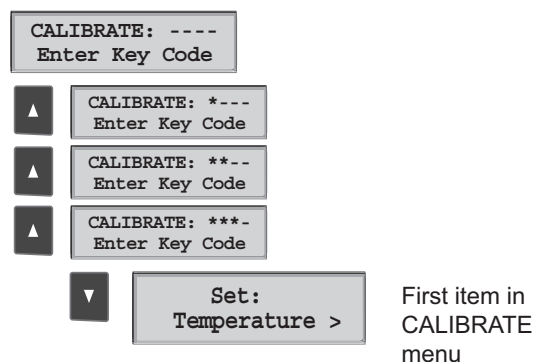

Notes on Steps 3 and 4:

- Refer to pages 6 and 7 for complete listing of menu items and their use.
- From the Step 3 display, pressing the UP and DOWN keys simultaneously will return the display to the VIEW menu.
- If no key is pressed for 10 minutes, display will also return to the VIEW menu.

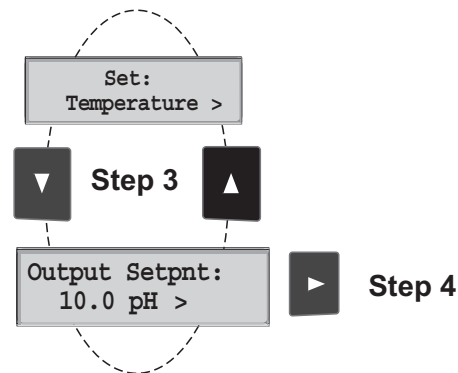

Step 3: Finished Editing?

Press the UP and DOWN keys simultaneously after saving the last setting to return to normal operation.

Notes on Steps 5 and 6:

- All output functions remain active during editing.
- Only the flashing element can be edited.
- RIGHT ARROW key advances the flashing element in a continuous loop.
- Edited value is effective immediately after pressing ENTER key.
- If no key is pressed for 10 minutes unit will restore the last saved value and return to step 3.
- Step 6 (pressing ENTER key) always returns you to Step 3.
- Repeat steps 3-6 until all editing is completed.

Step 5: Made an Error?

Press the UP and DOWN keys simultaneously while any element is flashing. This will recall the last saved value of the item being edited and return you to Step 3.

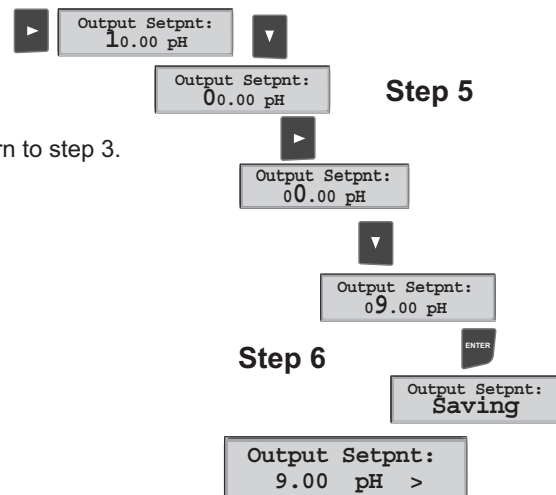

Calibrate Menu for pH

| Display (Factory settings shown) | Description |
|--|---|
| Set: Temperature > | Provides a maximum 25°C offset to match temperature measurement to external reference. |
| Set: Standard > | Applies a linear offset to the pH measurement. The ideal value is the average pH of your application. (A sample of your application at process temperature is recommended.) |
| Set: Slope > | Applies a slope to the pH measurement. The slope value and the standard value must be at least 2 pH units apart. The ideal values are the minimum and maximum values of your process. |
| Loop1 Source: pH > | Select the input source to be associated with the current loop output: pH or Temperature |
| Loop1 Range: pH 0.00 → 14.00 > | Select the minimum and maximum values for the 4-20 mA Current loop output. |
| Output1 Source: pH > | Select pH or Temperature as the source for the Open Collector Output. |
| Output1 Mode: Low > | Select the mode of operation for the Open Collector output: High, Low or proportional Pulse. The signal may be disabled if not in use. |
| Output1 Setpnt: 4.00 pH > | In Low or High Mode, the Open Collector output will be activated when the pH reaches this value. In Low or High mode, the Open Collector output will be deactivated at Setpoint ± Hysteresis, depending on High or Low Setpoint selection. (See details on page 4.) |
| Output1 Hys: 0.50 pH > | |
| Output1 Range: pH 4.00 → 8.00 > | If the output is in PULSE mode, set the start and end point of the range and also set the maximum pulse rate. (The maximum PULSE rate setting is 400 pulses per minute.) The combined Output Range and Pulse rate settings shown here indicate: "Start pulsing when the pH value is 4 and increase the pulse rate up to the maximum of 120 pulses per minute when the pH value reaches 8" |
| Output1 PlsRate: 120 Pulses/min > | |
| Last CAL: 04-20-07 > | Use this "note pad" to record important dates, such as annual recertification or scheduled maintenance. |





All Output1 functions will repeat for Output2; All Loop1 functions will repeat for Loop2.

EASY CAL Procedure - pH

- This procedure simplifies system calibration using standard 4.0, 7.0, 10.0 pH buffers only. If these pH buffers are not available, calibrate the system via the CALIBRATE menu, using the STANDARD and SLOPE settings.
- Access the CALIBRATE menu and set sensor temperature before performing EASY CAL for new electrode installations.
- Access EASY CAL menu from the view menu.

EASY CAL: ----
Enter Key Code

Press UP, UP, UP, DOWN buttons in sequence to enter menu,
XXXX will appear during code entry.

| To Calibrate: | Response: | To Accept: |
|---|--|---|
| <p>Place Sensor in pH Buffer #1</p>  <p>Place electrode tip in first pH buffer pH 7.0 = 0 mV pH 4.0 = 177 pH 10 = -177 Limit ± 50 mV</p> | <p>6.90 pH -005 mV</p> <p>Allow for stabilization</p>  <p>30 seconds*</p> | <p>6.90 pH -005 mV</p> <p>ENTER to accept</p> <p>7.00 pH -005 mV</p> |
| <p>Place Sensor in pH Buffer #2</p>  <p>Place electrode tip in second pH buffer.</p> | <p>3.93 pH +179 mV</p> <p>Allow for stabilization</p>  <p>30 seconds*</p> | <p>3.93 pH +179 mV</p> <p>Press ENTER to accept second buffer calibration.</p> <p>4.00 pH +179 mV</p> |
| <p>To exit menus and return to VIEW press UP and DOWN button at the same time</p>  | <p>Display returns to VIEW Menu in 10 minutes or when ENTER is pressed</p> | <p>Good Easy Cal Press <ENTER></p> |

Theoretical mV values

| pH @ 25°C | mV |
|-----------|------|
| 2 | +296 |
| 3 | +237 |
| 4 | +177 |
| 5 | +118 |
| 6 | +59 |
| 7 | +0 |
| 8 | -59 |
| 9 | -118 |
| 10 | -177 |
| 11 | -237 |
| 12 | -296 |

Options Menu for pH

| Display (Factory settings shown) | Description |
|----------------------------------|--|
| Contrast: 3 > | Adjust the LCD contrast for best viewing. A setting of 1 is lower contrast, 5 is higher. Select lower contrast if the display is in warmer ambient surroundings. |
| Averaging: Off > | OFF provides the most instantaneous output response to changes input value. LOW averaging = 4 seconds, HIGH averaging = 8 seconds of input signal. |
| Output1 Active: °C > | Active HIGH: This setting is used to turn a device (pump, valve) ON at the setpoint. Active LOW: This setting is used to turn a device (pump, valve) OFF at the setpoint. |
| Temp Display: °C > | Select temperature units: °C of °F. |
| Loop1 Adjust: 4.00 mA > | Adjust the minimum and maximum current output. The display value represents the precise current output. |
| Loop1 Adjust: 20.00 mA > | Adjustment limits: • 3.80 mA < 4.00 mA > 5.00 mA • 19.00 mA < 20.00 mA > 21.00 mA Use this setting to match the 8750 loop output to any external device. |
| Test Loop1: > | Press UP or DOWN keys to manually order any output current value from 3.6 mA to 21.00 mA to test current loop output. |
| Test Output1: > | Press UP or DOWN keys to manually toggle the state of the open collector output. |

Calibrate Menu for ORP





| Display (Factory settings shown) | Description |
|--------------------------------------|---|
| Set: Standard > | Applies a linear offset to the ORP measurement. The ideal value is the average pH of your application. (A sample of your application at process temperature is recommended.) |
| Set: Slope > | Applies a slope to the ORP measurement. The slope value and the standard value must be at least 120 mV apart. The ideal values are the minimum and maximum values of your application. |
| Loop1 Range: mV -1000 → +1000 > | Select the minimum and maximum ORP values for the 4-20 mA Current loop output. Minimum range is -1000 mV; Maximum range is +2000 mV. |
| Output1 Mode: Off > | Select the desired mode of operation for the Open Collector output: High, Low or proportional Pulse. The signal may also be disabled if not in use. |
| Output1 Setpnt: -500 mV > | In Low or High Mode, the Open Collector output will be deactivated when the ORP reaches this value. |
| Output1 Hys: 10 mV > | In Low or High mode, the Open Collector output will be deactivated at Setpoint ± Hysteresis, depending on High or Low Setpoint selection. (See details on page 4.) |
| Output1 Range: mV -500 → +500 > | If the output is in PULSE mode, set the start and end point of the range and also set the maximum pulse rate. (The maximum PULSE rate setting is 400 pulses per minute.) The combined Output Range and Pulse rate settings shown here indicate: "Start pulsing when the ORP value is -500 and increase the pulse rate up to the maximum of 120 pulses per minute when the ORP value reaches +500" |
| Output1 PlsRate: 120 pulses/min > | |
| Last Cal: 04-20-07 > | Use this "note pad" to record important dates, such as annual recertification or scheduled maintenance. |

EASY CAL Procedure - ORP

- This procedure simplifies system calibration using standard 4.0 pH and 7.0 pH buffers **saturated with Quinhydrone**. To calibrate using any other ORP buffer solutions, use the Standard and Slope functions in the CALIBRATE menu.
- Access EASY CAL menu from the view menu.

EASY CAL: ----
Enter Key Code

Press UP, UP, UP, DOWN buttons in sequence to enter menu,
**** will appear during code entry.

| To Calibrate: | Response: | To Accept: |
|--|--|--|
| <p>Place Sensor in ORP Buffer #1</p>  <p>Place electrode tip in first pH buffer;</p> <p>pH 7.0 87 mV pH 4.0 264 mV</p> | <p>* ORP: + 84 mV Input: + 82 mV</p> <p>Allow for stabilization</p>  <p>30 seconds*</p> | <p>* ORP: + 84 mV Input: + 82 mV</p> <p>ENTER to accept</p> <p>* ORP: + 87 mV Input: + 82 mV</p> |
| <p>Place Sensor in ORP Buffer #2</p>  <p>Place electrode tip in second (different) pH buffer.</p> <p>pH 4.0 264 mV pH 7.0 87 mV</p> | <p>* ORP: +262 mV Input: +260 mV</p> <p>Allow for stabilization</p>  <p>30 seconds*</p> | <p>* ORP: +262 mV Input: +260 mV</p> <p>Press ENTER to accept second buffer calibration.</p> <p>* ORP: +264 mV Input: +260 mV</p> |
| <p>To exit menus and return to VIEW press UP and DOWN button at the same time</p>  | <p>Display returns to VIEW Menu in 10 minutes or when ENTER is pressed</p> | <p>Good Easy Cal Press <ENTER></p> |

* For best results, gently stir the submerged electrode for approximately 5 seconds during the stabilization period. Large temperature differences from process fluids to buffers may require longer stabilization time.

Technical notes:

The difference between the actual mV and value shown is a good indication of the condition of the electrode. Differences in excess of 50 mV may indicate a need to service the electrode.

Options Menu for ORP

| Display (Factory settings shown) | Description |
|---|--|
| <p>Contrast: 3 ></p> | Adjust the LCD contrast for best viewing. A setting of 1 is lower contrast, 5 is higher. Select lower contrast if the display is in warmer ambient surroundings. |
| <p>Averaging: Off ></p> | OFF provides the most instantaneous output response to changes in input value. LOW averaging = 4 seconds, HIGH averaging = 8 seconds of input signal. Longer averaging produces more stable display and output response. |
| <p>Output1 Active: Low ></p> | Active HIGH: This setting is used to turn a device (pump, valve) ON at the setpoint. Active LOW: This setting is used to turn a device OFF at the setpoint. |
| <p>Loop 1 Adjust: 4.00 mA ></p> | Adjust the minimum and maximum current output. The display value represents the precise current output. Adjustment limits: • 3.80 mA < 4.00 mA > 5.00 mA • 19.00 mA < 20.00 mA > 21.00 ma Use this setting to match the 8750 loop output to any external device. |
| <p>Loop 1 Adjust: 20.00 mA ></p> | |
| <p>Test Loop1: ></p> | Press UP or DOWN keys to manually order any output current value from 3.6 mA to 21.00 mA to test current loop output. |
| <p>Test Output1: ></p> | Press UP or DOWN keys to manually toggle the state of the open collector output. |

Troubleshooting - pH

| Display Condition | Possible causes | Suggested Solutions |
|---|--|--|
| During EasyCal: "Out of Range Use Manual CAL" | <ol style="list-style-type: none"> 1. Required 4, 7 or 10 buffers not being used. 2. Sensor is depleted too severely to use EasyCal | <ol style="list-style-type: none"> 1. Use pH 4, 7, 10 buffers 2. Clean probe and retry EASY CAL. 3. Use Manual calibration for Standard and Slope if mV offset exceeds 50 mV. |
| During EasyCal: "Same Buffer" | Sensor was not moved from buffer #1 to buffer #2. | <ol style="list-style-type: none"> 1. Place sensor in correct buffer solution. 2. Use fresh buffer. |
| During CALIBRATE Std: "Standard too close to Slope!" | <ol style="list-style-type: none"> 1. pH Standard value within 2 pH units of Slope value 2. pH Sensor efficiency is inadequate | <ol style="list-style-type: none"> 1. Use pH values at least 2 pH units apart. 2. Clean pH sensor; replace if necessary 3. Use fresh buffer. |
| During CALIBRATE Slope: "Slope too close to Standard!" | <ol style="list-style-type: none"> 1. pH Slope value within 2 pH units of Standard value 2. pH Sensor efficiency is inadequate | <ol style="list-style-type: none"> 1. Use pH values at least 2 pH units apart. 2. Clean pH sensor; replace if necessary 3. Use fresh buffer. |
| During CALIBRATE: "Out of Range Check Sensor" | <ol style="list-style-type: none"> 1. No temperature or mV signal from sensor detected. 2. No connection between pH sensor and preamplifier. | <ol style="list-style-type: none"> 1. Check all wiring, contacts in preamplifier. 2. Verify sensor is securely installed. 3. Replace pH sensor. |
| During normal operation: Constant "15.00 pH" or constant "0.00 pH" with good temp value | mV input is less than 0 pH or greater than 15 pH. | <ol style="list-style-type: none"> 1. Recalibrate system. 2. Replace pH sensor 3. Replace preamplifier. |
| During normal operation: "Check Sensor?" | <ol style="list-style-type: none"> 1. No temperature or mV signal from sensor detected. 2. No connection between pH sensor and preamplifier. | <ol style="list-style-type: none"> 1. Check all wiring, contacts in preamplifier. 2. Verify sensor is securely installed. 3. Replace pH sensor. |

The mV value from the sensor when placed in a 7 pH buffer represents the sensor offset. Signet recommends servicing/replacing the sensor when the offset exceeds 50 mV.

The 3-2759 pH/ORP system tester allows simple system troubleshooting.

Troubleshooting - ORP

| Display Condition | Possible causes | Suggested Solutions |
|--|---|--|
| During EasyCal: "Out of Range Use Manual CAL" | <ol style="list-style-type: none"> 1. Required 4, 7 buffers with quinhydrone not being used. 2. Sensor is depleted too severely to use EasyCal. | <ol style="list-style-type: none"> 1. Use pH 4, 7 buffers saturated with quinhydrone. 2. Clean probe and retry EASY CAL. 3. Use Manual calibration for Standard and Slope if mV offset exceeds 50 mV. |
| During EasyCal: "Same Buffer" | Sensor was not moved from buffer #1 to buffer #2. | <ol style="list-style-type: none"> 1. Place sensor in correct buffer solution. 2. Use fresh buffer. |
| During CALIBRATE Std: "Standard too close to Slope!" | <ol style="list-style-type: none"> 1. ORP Standard value within 120 mV of Slope value. 2. ORP Sensor efficiency is inadequate. | <ol style="list-style-type: none"> 1. Use ORP values at least 120 mV apart. 2. Clean ORP sensor; replace if necessary. 3. Use fresh buffer. |
| During CALIBRATE Slope: "Slope too close to Standard!" | <ol style="list-style-type: none"> 1. ORP Slope value within 120 mV of Standard value. 2. ORP Sensor efficiency is inadequate. | <ol style="list-style-type: none"> 1. Use ORP values at least 120 mV apart. 2. Clean ORP sensor; replace if necessary. 3. Use fresh buffer. |
| During CALIBRATE: "Out of Range Check Sensor" | <ol style="list-style-type: none"> 1. No mV signal or sensor id from sensor detected. 2. No connection between ORP sensor and preamplifier. | <ol style="list-style-type: none"> 1. Check all wiring, contacts in preamplifier. 2. Verify sensor is securely installed. 3. Replace ORP sensor. |
| During normal operation: Constant "-1000" or constant "+2000" | mV input is less than -999 or greater than +1999. | <ol style="list-style-type: none"> 1. Recalibrate system. 2. Replace ORP sensor. 3. Replace preamplifier. |
| During normal operation: "Check Sensor?" | <ol style="list-style-type: none"> 1. No temperature or mV signal from sensor detected. 2. No connection between ORP sensor and preamplifier. | <ol style="list-style-type: none"> 1. Check all wiring, contacts in preamplifier. 2. Verify sensor is securely installed. 3. Replace ORP sensor. |

Ordering Information

| Mfr. Part No. | Code | Description |
|---------------|-------------|--|
| 3-8750-1 | 159 000 053 | pH/ORP transmitter Field mount |
| 3-8750-1P | 159 000 054 | pH/ORP transmitter Panel mount |
| 3-8750-2 | 159 000 055 | pH/ORP transmitter Field mount with relays |
| 3-8750-2P | 159 000 056 | pH/ORP transmitter Panel mount with relays |
| 3-8750-3 | 159 000 057 | pH/ORP transmitter Field mount with single input/dual output |
| 3-8750-3P | 159 000 058 | pH/ORP transmitter Panel mount with single input/dual output |

Accessories

| Mfr. Part No. | Code | Description |
|---------------|-------------|--|
| 3-2714 | 198 844 300 | Twist-Lock Flat pH electrode |
| 3-2714-HF | 198 844 305 | Twist-Lock Flat pH hydrofluoric acid resistant electrode (<2%) |
| 3-2716 | 198 844 302 | Twist-Lock Bulb pH electrode |
| 3-2716-DI | 198 844 306 | Twist-Lock Bulb pH electrode for process liquids (< 100 µs) |
| 3-2715 | 198 844 301 | Twist-Lock Flat ORP Electrode |
| 3-2717 | 198 844 303 | Twist-Lock Bulb ORP Electrode |
| 3-2720 | 198 864 602 | Twist-Lock Preamplifier, 1/4 in. NPT |
| 3-2720-2 | 198 864 603 | Twist-Lock Preamplifier, ISO 7/1-R 3/4 |
| P31542 | 198 801 630 | Red sensor cap for in-line installations |
| P31542-3 | 159 000 464 | Blue sensor cap for in-line installations |
| 3-2759 | 159 000 762 | pH/ORP system tester (includes bypass adapter) |
| 3-2759.393 | 159 000 765 | 2720 Adapter Cable |
| P31515-0P200 | 159 000 630 | PVC Pipe Adapter |
| P31515-0C200 | 159 000 631 | CPVC Pipe Adapter |
| P31515-0V200 | 159 000 459 | PVDF Pipe Adapter |
| 1220-0021 | 198 801 186 | O-ring, FPM (standard) |
| 1224-0021 | 198 820 006 | O-ring, EPR |
| 1228-0021 | 198 820 007 | O-ring, Kalrez® |
| 3-8050 | 159 000 184 | Universal mounting kit |
| 3-8050.395 | 159 000 186 | Splashproof rear cover |
| 3-8050.396 | 159 000 617 | RC Filter kit (for relay use) |
| 3-8052 | 159 000 188 | 3/4 in. Integral mounting kit |
| 3-8052-1 | 159 000 755 | 3/4 in. NPT mount junction box |
| 3-0000.596 | 159 000 641 | Heavy duty wall mount bracket |
| 3-0700.390 | 198 864 403 | pH buffer kit |
| 3-8050.392 | 159 000 640 | Model 200 retrofit adapter |
| 3-5000.598 | 198 840 225 | Surface mount bracket |
| 3-5000.399 | 198 840 224 | 5 x 5 inch adapter plate for Signet retrofit |
| 3-9000.392 | 159 000 368 | Liquid-tight connector kit, 3 sets, 1/2 in. NPT |
| 3-9000.392-1 | 159 000 839 | Liquid-tight connector kit, 1 set, 1/2 in. NPT |
| 3-9000.392-2 | 159 000 841 | Liquid-tight connector kit, 1 set, PG 13.5 |
| 7300-7524 | 159 000 687 | 24 VDC Power Supply 7.5 Ω, 300mA |
| 7300-1524 | 159 000 688 | 24 VDC Power Supply 15 Ω, 600mA |
| 7300-3024 | 159 000 689 | 24 VDC Power Supply 30 Ω, 1.3 A |
| 7300-5024 | 159 000 690 | 24 VDC Power Supply 50 Ω, 2.1 A |
| 7300-1024 | 159 000 691 | 24 VDC Power Supply 100 Ω, 4.2 A |
| 3-3719-11 | 159 000 804 | pH/ORP Wet-Tap, 1 1/2 in. NPT |
| 3-3719-21 | 159 000 805 | pH/ORP Wet-Tap, 2 in. NPT |
| 3-3719-12 | 159 000 806 | pH/ORP Wet-Tap, ISO 7/1-R 1 1/2 |
| 3-3719-22 | 159 000 807 | Wet-Tap Assembly, ISO 7/1-R 2 |
| 3-2716-WT | 159 000 809 | Twist-Lock pH Electrode (use with 3719 Wet-Tap) |
| 3-2717-WT | 159 000 811 | Twist-Lock ORP Electrode (use with 3719 Wet-Tap) |
| 2007-0225 | 159 000 812 | PP Clamp-on Saddle, 2 1/2 in. x 1 1/2 in. (ASTM, NPT) |
| 2007-0230 | 159 000 813 | PP Clamp-on Saddle, 3 in. x 1 1/2 in. (ASTM, NPT) |
| 2007-0240 | 159 000 814 | PP Clamp-on Saddle, 4 in. x 1 1/2 in. (ASTM, NPT) |
| 2007-0260 | 159 000 815 | PP Clamp-on Saddle, 6 in. x 2 in. (ASTM, NPT) |
| 2007-0280 | 159 000 816 | PP Clamp-on Saddle, 8 in. x 2 in. (ASTM, NPT) |
| 2007-0210 | 159 000 817 | PP Clamp-on Saddle, 10 in. x 2 in. (ASTM, NPT) |
| 2007-0212 | 159 000 818 | PP Clamp-on Saddle, 12 in. x 2 in. (ASTM, NPT) |



George Fischer Signet, Inc., 3401 Aerojet Avenue, El Monte, CA 91731-2882 U.S.A. • Tel. (626) 571-2770 • Fax (626) 573-2057
For Worldwide Sales and Service, visit our website: www.gfsignet.com • Or call (in the U.S.): (800) 854-4090

