

Warranty, Service & Repair

To register your product with the manufacturer, go to the Flowline website for on-line registration. The website address is as follows:

www.flowline.com

On-line Warranty Registration can be found under Contact Us in the Navigation Bar along the side of the home page.

If for some reason your product must be returned for factory service, contact Flowline Inc. at (562)598-3015 to receive a Material Return Authorization number (MRA), providing the following information:

1. Part Number, Serial Number
2. Name and telephone number of someone who can answer technical questions related to the product and its application.
3. Return Shipping Address
4. Brief Description of the Symptom
5. Brief Description of the Application

Once you have received a Material Return Authorization number, ship the product prepaid in its original packing to:

Flowline Factory Service
MRA _____
10500 Humbolt Street
Los Alamitos, CA 90720

To avoid delays in processing your repair, write the MRA on the shipping label. Please include the information about the malfunction with your product. This information enables our service technicians to process your repair order as quickly as possible.

FLOWLINE®

Switch Pak™ w/ Compact Relay Controller A _ 1 3 Series Owner's Manual



Version 0.1A

© 2005 FLOWLINE Inc.

All rights reserved.

Manual # LM900005 05/05

WARRANTY

Flowline warrants to the original purchaser of its products that such products will be free from defects in material and workmanship under normal use and service for a period which is equal to the shorter of one year from the date of purchase of such products or two years from the date of manufacture of such products.

This warranty covers only those components of the products which are non-moving and not subject to normal wear. Moreover, products which are modified or altered, and electrical cables which are cut to length during installation are not covered by this warranty.

Flowline's obligation under this warranty is solely and exclusively limited to the repair or replacement, at Flowline's option, of the products (or components thereof) which Flowline's examination proves to its satisfaction to be defective. FLOWLINE SHALL HAVE NO OBLIGATION FOR CONSEQUENTIAL DAMAGES TO PERSONAL OR REAL PROPERTY, OR FOR INJURY TO ANY PERSON.

This warranty does not apply to products which have been subject to electrical or chemical damage due to improper use, accident, negligence, abuse or misuse. Abuse shall be assumed when indicated by electrical damage to relays, reed switches or other components. The warranty does not apply to products which are damaged during shipment back to Flowline's factory or designated service center or are returned without the original casing on the products. Moreover, this warranty becomes immediately null and void if anyone other than service personnel authorized by Flowline attempts to repair the defective products.

Products which are thought to be defective must be shipped prepaid and insured to Flowline's factory or a designated service center (the identity and address of which will be provided upon request) within 30 days of the discovery of the defect. Such defective products must be accompanied by proof of the date of purchase.

Flowline further reserves the right to unilaterally waive this warranty and to dispose of any product returned to Flowline where:

- a. There is evidence of a potentially hazardous material present with product.
- b. The product has remained unclaimed at Flowline for longer than 30 days after dutifully requesting disposition of the product.

THERE ARE NO WARRANTIES WHICH EXTEND BEYOND THE DESCRIPTION ON THE FACE OF THIS WARRANTY. This warranty and the obligations and liabilities of Flowline under it are exclusive and instead of, and the original purchaser hereby waives, all other remedies, warranties, guarantees or liabilities, express or implied. EXCLUDED FROM THIS WARRANTY IS THE IMPLIED WARRANTY OF FITNESS OF THE PRODUCTS FOR A PARTICULAR PURPOSE OR USE AND THE IMPLIED WARRANTY OF MERCHANTABILITY OF THE PRODUCTS.

This warranty may not be extended, altered or varied except by a written instrument signed by a duly-authorized officer of Flowline, Inc.

SPECIFICATIONS

Step One

Specifications:

| | |
|--------------------|----------------------------------------------------------------------------|
| Length: | 6" to 10' (15 cm to 3m) |
| Switch points: | 1 (set by factory) |
| Orientation: | ± 30° vertical |
| Supply voltage: | 120/240 VAC @ 50-60 Hz. |
| Contact type: | (1) SPDT relay |
| Contact rating: | 250 VAC @ 10A |
| Contact delay: | 0-60 seconds |
| LED indication: | Power, relay and sensor status |
| Strobe type: | _21_: Xenon tube _22_: N/A |
| Strobe flash: | _21_: 1 per second _22_: N/A |
| Process temp.: | F: -40° to 194° C: -40° to 90° |
| Electronics temp.: | F: -40° to 140° C: -40° to 60° |
| Pressure: | AU13: 150 psi (10 bar) AZ13: 150 psi (10 bar) AV13: 25 psi (1.7 bar) |
| Wetted material: | 42_: PP 52_: PVDF Kynar® |
| Process mount: | _2_3: 2" NPT _2_7: 1 1/2" G |
| Enclosure rating: | NEMA 4X (IP65) |
| Installed height: | _21_: 6.5" (16.5 cm) _22_: 4.9" (12.4 cm) |
| Encl. material: | _21_: PP, UL94VO and polycarbonate _22_: PP, UL94VO |
| Conduit entrance: | Single, 1/2" NPT |
| Classification: | General purpose |
| CE compliance: | EN 50082-2 immunity EN 55011 emission EN 61010-1 safety |

Sensor Technologies:



Vibration (LZ10 series)

Typically applied in wastewater media with light coating and/or foaming characteristics



Ultrasonic (LU10 series)

Broadly applied in chemical, solvent, hydrocarbon and light weight oil media



Buoyancy (LV10 series)

Best applied in clean water or water-like chemical media that is non-coating or scaling

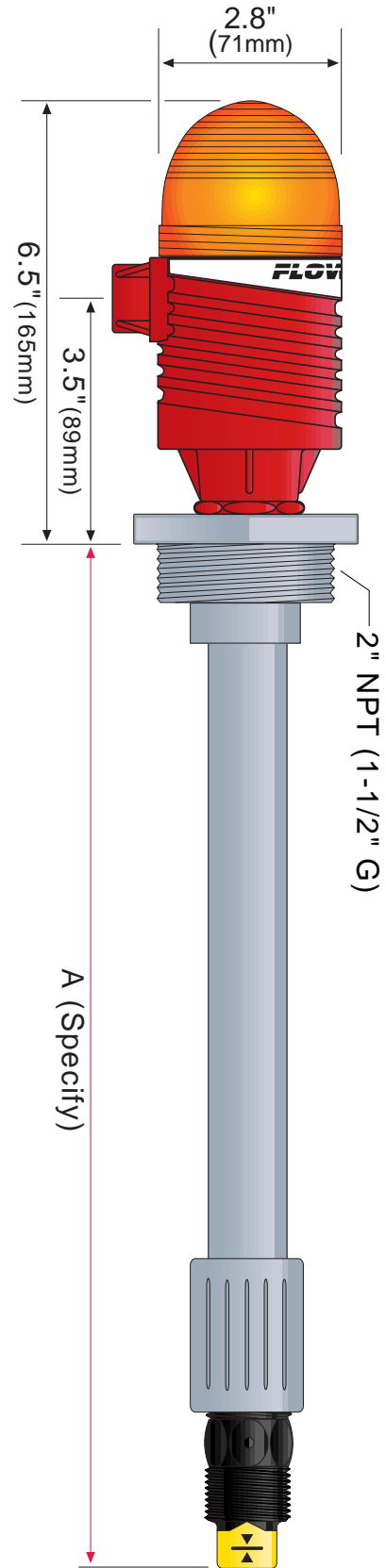

COMPONENTS

Step Two

Standard Configuration: (AU13-_22_, AV13-_21_ or AZ13-_21_)

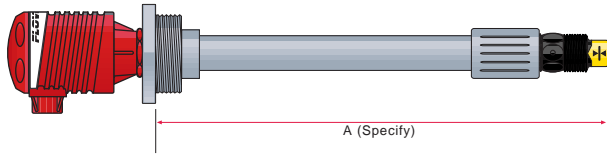

Strobe Alert Configuration: (AU23-432_, AV23-432_ or AZ23-432_)

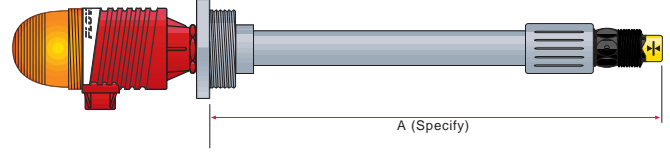

Ultrasonic AU13-4223

1 x LU10-1305
1 x LM45-1001
1 x LC10-1001

Buoyancy AV13-4223

1 x LV10-1301
1 x LM45-1001
1 x LC10-1001

Vibration AZ13-4223

1 x LZ12-1405
1 x LM45-1001
1 x LC10-1001

AU13-4227

1 x LU10-1325
1 x LM45-1061
1 x LC10-1051

AV13-4227

1 x LV10-1351
1 x LM45-1061
1 x LC10-1051

AZ13-4227

1 x LZ12-1425
1 x LM45-1061
1 x LC10-1051

AU13-5223

1 x LU10-2305
1 x LM45-5001
1 x LC10-1001

AV13-5223

1 x LV10-5301
1 x LM45-5001
1 x LC10-1001

AU13-5227

1 x LU10-2325
1 x LM45-5061
1 x LC10-1051

AV13-5227

1 x LV10-5351
1 x LM45-5061
1 x LC10-1051

Ultrasonic AU13-4213

1 x LU10-1305
1 x LM45-1001
1 x LC10-1002

Buoyancy AV13-4213

1 x LV10-1301
1 x LM45-1001
1 x LC10-1002

Vibration AZ13-4213

1 x LZ12-1405
1 x LM45-1001
1 x LC10-1002

AU13-4217

1 x LU10-1325
1 x LM45-1061
1 x LC10-1052

AV13-4217

1 x LV10-1351
1 x LM45-1061
1 x LC10-1052

AZ13-4217

1 x LZ12-1425
1 x LM45-1061
1 x LC10-1052

AU13-5213

1 x LU10-2305
1 x LM45-5001
1 x LC10-1002

AV13-5213

1 x LV10-5301
1 x LM45-5001
1 x LC10-1002

AU13-5217

1 x LU10-2325
1 x LM45-5061
1 x LC10-1052

AV13-5217

1 x LV10-5351
1 x LM45-5061
1 x LC10-1052

Component List:

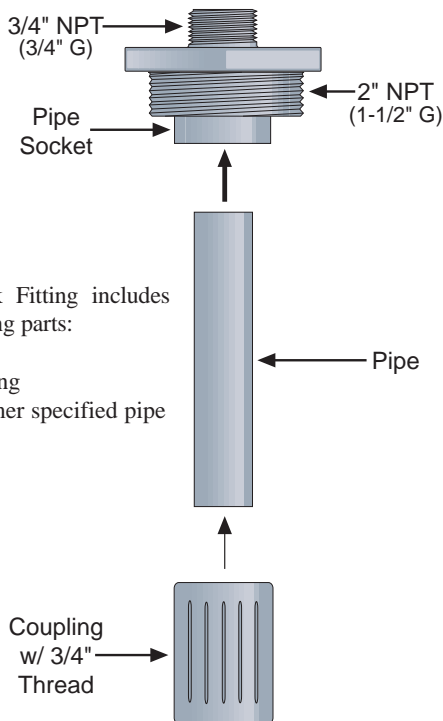

Switch Pak Fitting includes the following parts:

- 1 Fitting
- 1 Coupling
- 1 Customer specified pipe

Switch Pak Fitting

P/N: LM45-1001, LM45-1061, LM45-5001 or LM45-5061

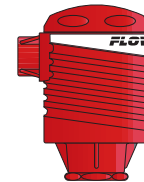

Compact Relay Controller

P/N: LC10-1001, LC10-1051, LC10-1002 or LC10-1052



Switch-Tek Level Switch

P/N: LU10-1305, LU10-1325, LU10-2305, LU10-2325, LV10-1301, LV10-1351, LV10-5301, LV10-5351, or LZ12-1405

SAFETY PRECAUTIONS

Step Three

⚠ About this Manual: PLEASE READ THE ENTIRE MANUAL PRIOR TO INSTALLING OR USING THIS PRODUCT. This manual includes information on the Switch Pak™ with Compact Relay Controller: AU13-__2__, AZ13-__2__ and AV13-__2__. The units are identical except for the material of construction, choice of Strobe Alert and the sensors technology.

⚠ User's Responsibility for Safety: Flowline manufactures a wide range of liquid level sensors, controllers, and mounting systems. It is the user's responsibility to select components that are appropriate for the application, install them properly, perform tests of the installed system, and maintain all components. The failure to do so could result in property damage or serious injury.

⚠ Proper Installation and Handling: Use a proper sealant with all installations. Never overtighten the components. Always check for leaks prior to system start-up.

⚠ Material Compatibility:

Polypropylene (PP, a polyolefin): Sensor, Switch Pak™ fitting, Controller Housing.

Polyvinylidene Fluoride (PVDF): Sensor and SWitch Pak™ fitting.

Viton (a fluorocarbon): O-ring.

Make sure that the application liquids are compatible with the materials that will be wetted. To determine the chemical compatibility between the components and its application liquids, refer to the Compass Corrosion Guide, available from Compass Publications (phone 858-589-9636).

⚠ Temperature and Pressure: Switch Pak™ is designed for use in application temperatures up to 90° C (194° F). The Vibration and Ultrasonic packages are designed for pressurized applications up to 150 psi (10 bar) and the Buoyancy package is designed for use up to 25 psi (1.7 bar).

⚠ Wiring and Electrical: Electrical wiring of any liquid level control system should be performed in accordance with all applicable national, state, and local codes. Take care not to cut or break the outer insulation jacket of wiring that may be immersed while routing cables in the Switch Pak™ system. Such breaks of the liquid seal of the sensor system may lead to component failure.

⚠ Flammable, Explosive and Hazardous Applications: The AU13-__2__, AV13-__2__ and AZ13-__2__ Switch Pak™ should not be used within classified hazardous environments.

⚠ Make a Fail-Safe System: Design a fail-safe system that accommodates the possibility of system or power failure. In critical applications, Flowline recommends the use of redundant back-up systems and alarms in addition to the primary system.

ASSEMBLY OF SWITCH PAK™

Step Four

About Switch Pak™: Flowline's Switch Pak™ with Compact Relay Controller Assembly is a single-point mounting system for installing one level sensor vertically within a tank. The compact relay controller features a 120/240 VAC controller with a 250 VAC, 10A SPDT relay contract. Switch Pak™ mounts vertically through a standard 2" NPT (1 1/2" G) tank adapter, or on a side mount bracket (such as the LM50-1001).

Relay Controller: The level switch is pre-wired before shipment to the 2-pole terminal strip [Input 1 (+) & (-)]. The switch technologies used to indicate level are either Ultrasonic, Buoyancy or Vibration. The Compact Relay Controller provides a 1/2" Conduit connection and 6 poles for wire termination of power and relay contact. Use the AC, AC and GND terminals for providing power. Use the NC, NC and COM terminals for interfacing to the relay contact.



Compact Relay Controller (inside shown)

Vibration (LZ12-1405) Wire Configuration:

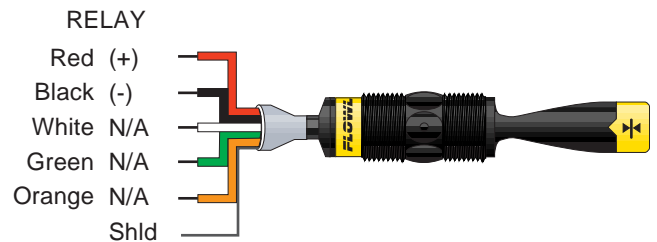

Ultrasonic (LU10-__305 or LU10-__325) Wire Configuration:

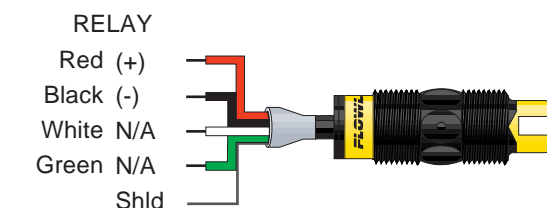

Buoyancy (LV10-__301 or LV10-__351) Wire Configuration:

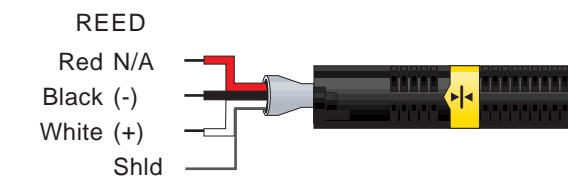

INSTALLATION

Step Five

Switch Pak™, In-Tank Installation:

Flowline's Switch Pak™ mounting system is an in-tank fitting, which enables users to install any technology, along the entire length of track. Switch Pak™ may be installed thru the top wall of any tank or flange, using a standard 2" NPT tank adapter or blind flange. If tank top is not available, Flowline's side mount bracket, LM50-1001, enables Switch Pak™ to be installed directly to the side wall or lip of the tank.

Tank Adapter:

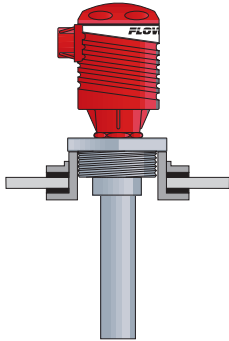

Flange Mounting:

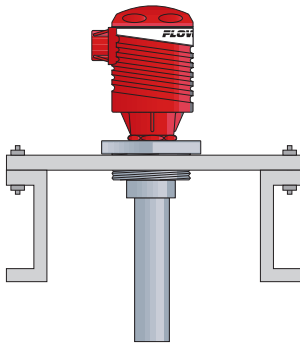

Side Mount Bracket:

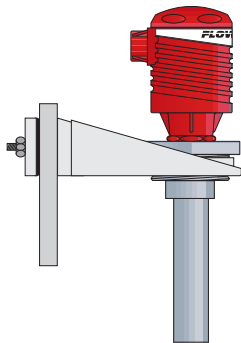

Lip of Tank

Side-Wall

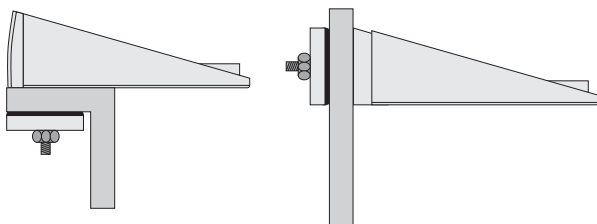

GUIDE TO CONTROLS

Step Six

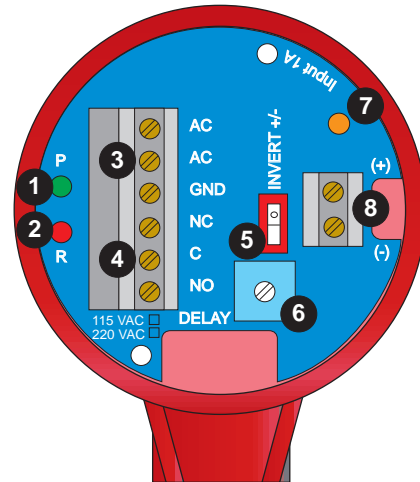

- 1. Power indicator:** This green LED lights when AC power is ON.
- 2. Relay indicator:** This red LED will light whenever the controller energizes the relay, in response to the proper condition at the sensor inputs and after the time delay.
- 3. AC Power terminals:** Connection of 120 VAC power to the controller. The setting may be changed to 240 VAC if desired. This requires changing internal jumpers; this is covered in the Installation section of the LC10/11 Series Manual. Polarity (neutral and hot) does not matter.
- 4. Relay terminals (NC, C, NO):** Connect the device you wish to control (pump, alarm etc.) to these terminals: supply to the COM terminal, and the device to the NO or NC terminal as required. The switched device should be a noninductive load of not more than 10 amps; for reactive loads the current must be derated or protection circuits used. When the red LED is ON and the relay is in the energized state, the NO terminal will be closed and the NC terminal will be open.
- 5. Invert switch:** This DIP switch reverses the logic of the relay control in response to the sensor(s): conditions that used to energize the relay will make it turn off and vice versa.
- 6. Time Delay:** After the input(s) change(s) state, this control sets a delay from 0.15 to 60 seconds before the relay will respond.
- 7. Input 1A indicator:** These amber LED will light immediately whenever the appropriate sensor attached to the terminals detects liquid, and will turn off when it is dry.
- 8. Input terminals:** Connect the wiring from the sensors to these terminals. Note the polarity: (+) is a 13.5 VDC, 27 mA power supply, and (-) is the return path from the sensor. If polarity is reversed, the sensors will not work.

WIRING

Step Seven

VAC Power Input Wiring: Observe the labeling on the controller. *Note: Polarity does not matter with the AC input terminal.*

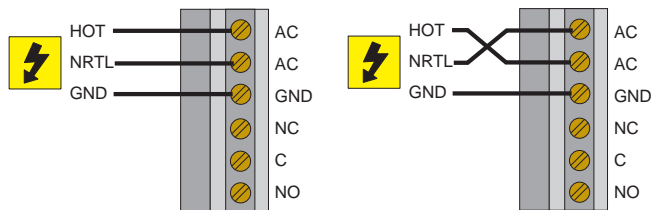

Relay Input Wiring: The relay is a single pole, double throw type rated at 250 Volts AC, 10 Amps. The terminals Normally Open (NO) and Normally Closed (NC) will be used in different applications. Remember that the "normal" state is when the relay coil is de-energized and the Red relay LED is OFF (de-energized).

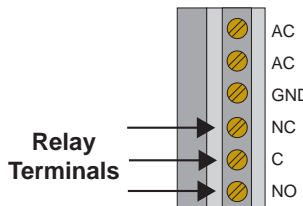

A typical application for the Switch Pak™ with Compact Relay Controller is to operate a pump or valve between the two set points (automatic fill or empty). In this application, a pump or valve can be wired to either the Normally Open (NO) or Normally Closed (NC) side of the relay.

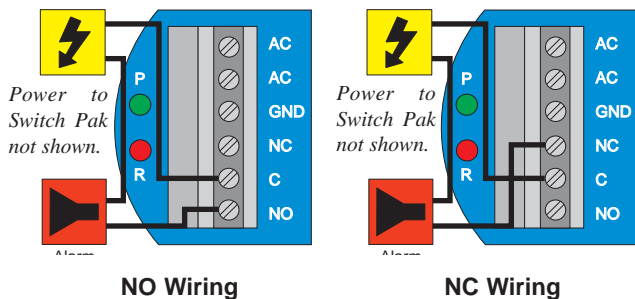

Strobe Alert Output

With the Strobe Alert wired NO, the strobe will flash when the Red LED is ON (Invert OFF). The strobe will flash when the Red LED is OFF when wired NC or by turning the Invert ON. If the strobe is wired NC and the Invert is ON, the strobe will flash when the Red LED is ON (same as NO wiring and Invert OFF).

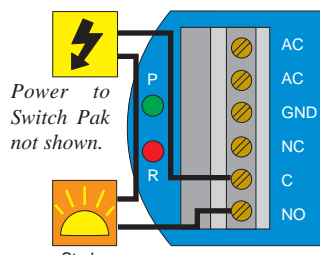

MAINTENANCE

Step Eight

General: The Switch Pak™ with Compact Relay Controller requires no periodic maintenance except cleaning as required. It is the responsibility of the user to determine the appropriate maintenance schedule, based on the specific characteristics of the application liquids.

Cleaning Procedure:

- Power:** Make Sure that all power to the sensor, controller and/or power supply is completely disconnected.
- Sensor Removal:** Make sure that the tank is in a state where it is safe to remove the sensors. Carefully, remove the Switch Pak™ from the installation.
- Cleaning the Sensor:** Use a soft bristle brush and mild detergent, carefully wash the Switch Pak™. Do not use harsh abrasives such as steel wool or sandpaper, which might damage the surface sensor. Do not use incompatible solvents which may damage the sensor's PP or Ryton plastic body.
- Sensor Installation:** Follow the appropriate steps of installation as outlined in the installation section of this manual.

Controller Logic:

- Power LED:** Make sure the Green power LED is On when power is supplied to the controller.
- Input LED(s):** The input LED on the controller will be Amber when the switch is wet and Off when the switch is dry. *Note: see Step 5 regarding reed switches.* If the LED's are not switching the input LED, test the level switch.
- Relays:** When both inputs are wet (Amber LED's On), the relay will be energized (Red LED On). After that, if one switch becomes dry, the relay will remain energized. Only when both switches are dry (both amber LED's Off) will the controller de-energize the relay. The relay will not energize again until both switches are wet. See the Relay Latch Logic Chart below for further explanation.

Current Test (Ultrasonic and Vibration only):

Used to verify if the sensor is indicating a wet or dry condition. This test uses only two wires (Red and Black). The sensor draws 5 mA (ultrasonic) or 8 mA (vibration) when it is dry, and 19 mA when wet. The White and Green wires are not used.

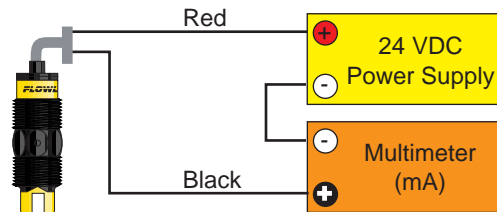

Contact Test (Buoyancy only):

Used to verify if the reed switch is switching between dry (open) and wet (closed). Check for continuity across Black and White (open for dry and closed for wet). Checking across Black and Red will result in a closed when dry and open when wet condition.

