

SINGLE PHASE VENTILATED:

Series 35: .050 kVA - .750 kVA – Series 80: 1.0 kVA - 5.0 kVA

Features

- **UL Listed, File E3210.**
- **CSA Certified, File LR 560.**
- **Copper windings** and copper lead wire terminations used throughout.
- **Series 35 has a UL Class 105°C insulation system** with 55°C temperature rise at a maximum ambient of 40°C. This insures a long life and cool operating temperatures.
- **Series 80 has a UL Class 180°C insulation system** with 115°C temperature rise at a maximum ambient of 40°C.
- **NEMA-3R**, wall mount enclosure suitable for indoor or outdoor use. May be used in banks of 2 or 3 units for standard three phase voltages

and nonstandard, open delta auto-transformer applications. (Note: .050 kVA - .100 kVA are in a NEMA-1 enclosure)

- **Multiple knockouts** provide convenient conduit entry and exit locations through the front access wiring compartment.
- **Ground studs** provided for bonding compatibility with both metallic and nonmetallic conduit.
- **Nonstandard designs** are available by consulting the factory or your Dongan representative.
- Double wound, isolation type transformers.



SINGLE PHASE ENCAPSULATED:

Series 85 ISO-Shield: .250 kVA - 25 kVA

Features

- **UL Listed, File E3210, .250 - 10 kVA.**
- **UL Listed, File E78234, 15 - 25 kVA.**
- **CUL Listed through UL File E3210.**
- **Electrostatic shield** between primary and secondary windings provides cleaner output voltage and helps to reduce spikes and transients.

- **Epoxy-silica encapsulated** core and coil provides a transformer particularly well suited for harsh commercial and industrial applications.
- **Copper windings** and copper lead wire terminations used throughout.
- **UL Class 180°C insulation system** with 115°C temperature rise at a maximum ambient of 40°C.
- **NEMA-3R**, wall mount enclosure suitable for indoor or outdoor use. May be used in banks of 2 or 3 units for standard three phase voltages and nonstandard, open delta autotransformer applications.
- **Multiple knockouts** provide convenient conduit entry and exit locations through the front and bottom access wiring compartment covers.
- **Ground studs** provided for bonding compatibility with both metallic and nonmetallic conduit.
- **Nonstandard designs** are available by consulting the factory or your Dongan representative.
- Double wound, isolation type transformers.



Single Phase - General Purpose

SINGLE PHASE VENTILATED CABINET STYLE:

Series 61 ISO-Shield: 7.5 kVA - 100 kVA

Features

- **UL Listed, File E78234.**
- **CUL Listed through UL File E3210.**
- **Electrostatic shield** between primary and secondary windings provides cleaner output voltage and helps to reduce spikes and transients.
- **Aluminum windings** connect to bus bar style terminations equipped with NEMA standard holes for compression style or ring terminals.



- **UL Class 220°C insulation system** with a 150°C temperature rise at full load and a maximum ambient of 40°C.
- **NEMA-3R**, ventilated, cabinet style, floor mount enclosure suitable for indoor or outdoor use. **No extra rainshields required for outdoor use.** May also be used in banks of 2 or 3 units for three phase isolation or autotransformer applications.
- **Vibration dampening pads** provide quiet operation.
- **Wall Mounting brackets** are available in sizes up to 50 kVA
- **Ground studs** provided for bonding compatibility with both metallic and nonmetallic conduit.
- **Core and coil and nonstandard designs** are available by consulting the factory or your Dongan representative.
- Double wound, isolation type transformers.

SINGLE PHASE: 7.5 kVA - 50 kVA

61 Series Optional Wall Mounting Brackets

Single Phase 7.5 kVA - 25 kVA

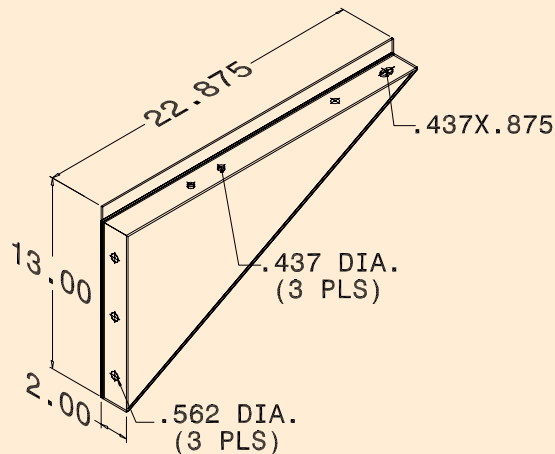

Catalog No. BR - 890

Single Phase 37.5 kVA - 50 kVA

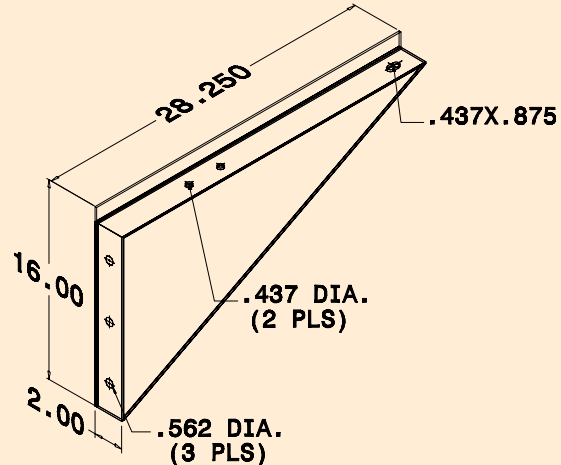

Catalog No. BR - 892

Primary Volts 240 X 480, Secondary Volts 120 / 240

General Information				Winding Specifications				Dimensions			
kVA Cap.	Catalog Number	Hz.	Wgt. Lbs	Taps	Maximum Amps		Conn Dia. Pg. 15	Height A	Width B	Depth C	Outline Dwg.
					Pri.	Sec.					
.050	35-1005	50/60	3.3	0	.2 / .1	.4 / .2	1	6.37	3.75	3.37	1
.100	35-1010	50/60	5	0	.4 / .2	.8 / .4	1	6.37	3.75	3.37	1
.150	35-1015	50/60	7	0	.6 / .3	1.2 / .6	1	7.00	4.00	3.63	2
.250	85-1020SH	50/60	14	0	1.0 / .52	2.0 / 1.0	4	12.00	4.87	5.25	3
.500	85-1025SH	50/60	18	0	2.0 / 1.0	4.1 / 2.0	4	12.00	4.87	5.25	3
.750	85-1030SH	50/60	22	0	3.1 / 1.6	6.2 / 3.1	4	12.00	4.87	5.25	3
1.0	85-1035SH	60	29	0	4.1 / 2.0	8.3 / 4.1	4	15.25	5.75	5.87	3
1.5	85-1040SH	60	37	0	6.2 / 3.1	12.5 / 6.2	4	15.25	5.75	5.87	3
2.0	85-1045SH	60	42	0	8.3 / 4.1	16.6 / 8.3	4	15.25	5.75	5.87	3
3.0	85-1050SH	60	62	0	12.5 / 6.2	25.0 / 12.5	4	15.25	8.25	7.87	3
3.0	85-1450SH	60	62	4	12.5 / 6.2	25.0 / 12.5	2	15.25	8.25	7.87	3
5.0	85-1055SH	60	102	0	20.8 / 10.4	41.6 / 20.8	4	15.25	8.25	7.87	3
5.0	85-1455SH	60	102	4	20.8 / 10.4	41.6 / 20.8	2	15.25	8.25	7.87	3
7.5	85-1060SH	60	131	0	31 / 15.6	62 / 31	4	15.75	14.25	8.75	4
7.5	85-1460SH	60	131	4	31 / 15.6	62 / 31	2	15.75	14.25	8.75	4
10	85-1065SH	60	152	0	41 / 20	83 / 41	4	15.75	14.25	8.75	4
10	85-1465SH	60	152	4	41 / 20	83 / 41	2	15.75	14.25	8.75	4
15	85-1070SH	60	270	0	62 / 31	125 / 62	4	19.38	17.56	11.50	4
15	85-1470SH	60	270	4	62 / 31	125 / 62	2	19.38	17.56	11.50	4
25	85-1075SH	60	300	0	104 / 52	208 / 104	4	19.38	17.56	11.50	4
25	85-1475SH	60	300	4	104 / 52	208 / 104	2	19.38	17.56	11.50	4

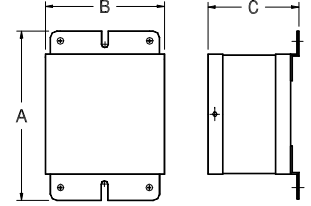

Outline Drawing 1
Wall Mount - Ventilated - NEMA 1

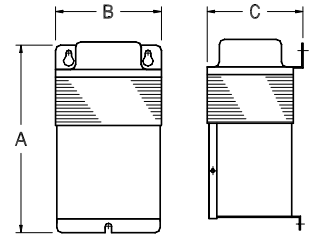

Outline Drawing 2
Wall Mount - Ventilated - NEMA 3R

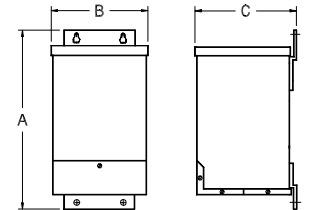

Outline Drawing 3
Wall Mount - Encapsulated - NEMA 3R
Note: 3 kVA & 5kVA 85 Series are also available in Outline Drawing 4 Configuration

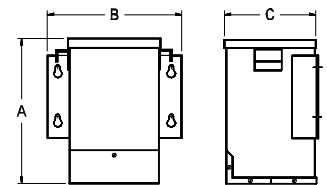

Outline Drawing 4
Wall Mount - Encapsulated - NEMA 3R

Floor Mount, Cabinet Style Enclosure

7.5	61-1460SH	60	125	4	31 / 15.6	62 / 31	2	22.00	16.00	14.00	5
10	61-1465SH	60	133	4	41 / 20	83 / 41	2	22.00	16.00	14.00	5
15	61-1470SH	60	185	4	62 / 31	125 / 62	2	23.50	18.62	16.00	5
25	61-1475SH	60	281	4	104 / 52	208 / 104	2	23.50	18.62	16.00	5
37.5	61-1680SH	60	384	6	156 / 78	312 / 156	3	32.00	27.00	26.25	5
50	61-1685SH	60	445	6	208 / 104	416 / 208	3	32.00	27.00	26.25	5
75	61-1690SH	60	663	6	312 / 156	625 / 312	3	41.00	34.00	26.75	5
100	61-1695SH	60	732	6	416 / 208	833 / 416	3	41.00	34.00	26.75	5

Primary Volts 240 X 480, Secondary Volts 120 - Fused

General Information				Winding Specifications				Dimensions			
kVA Cap.	Catalog Number	Hz.	Wgt. Lbs	Taps	Maximum Amps		Conn Dia. Pg. 16	Height A	Width B	Depth C	Outline Dwg. Pg. 24
					Pri.	Sec.					
.100	35-2010	50/60	5	0	.4 / .2	.8	11	6.37	3.75	3.38	6
.150	35-2015	50/60	7	0	.6 / .3	1.2	11	7.00	4.00	3.63	7
.250	35-2020	50/60	11	0	1.0 / .52	2.0	11	7.50	4.50	4.00	7
.500	35-2025	50/60	20	0	2.0 / 1.0	4.1	11	9.16	5.38	4.56	7
.750	35-2030	50/60	29	0	3.1 / 1.6	6.2	11	10.75	5.50	4.75	7
1.0	80-2035	50/60	29	0	4.1 / 2.0	8.3	11	10.88	5.50	4.75	7
1.5	80-2040	50/60	37	0	6.2 / 3.1	12.5	11	10.19	6.50	5.66	7

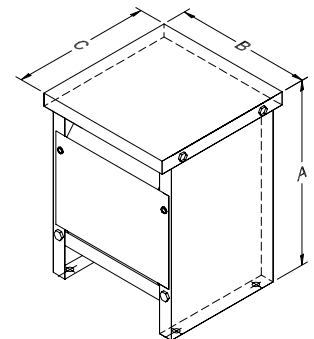

Outline Drawing 5
Floor Mount - Ventilated - NEMA 3R

Single Phase - General Purpose

Primary Volts 208, Secondary Volts 120 / 240

General Information				Winding Specifications				Dimensions			
kVA Cap.	Catalog Number	Hz.	Wgt. Lbs	Taps	Maximum Amps		Conn Dia. Pg. 15	Height A	Width B	Depth C	Outline Dwg.
					Pri.	Sec.					
.100	35-3010	50/60	5	0	.4	.8 / .4	5	6.37	3.75	3.37	1
.150	35-3015	50/60	7	0	.7	1.2 / .6	5	7.00	4.00	3.63	2
.250	85-3020SH	50/60	15	0	1.2	2.0 / 1.0	6	12.00	4.87	5.25	3
.500	85-3025SH	50/60	18	0	2.4	4.1 / 2.0	6	12.00	4.87	5.25	3
.750	85-3030SH	50/60	22	0	3.6	6.2 / 3.1	6	12.00	4.87	5.25	3
1.0	85-3035SH	60	29	0	4.8	8.3 / 4.1	6	15.25	5.75	5.87	3
1.5	85-3040SH	60	37	0	7.2	12.5 / 6.2	6	15.25	5.75	5.87	3
2.0	85-3045SH	60	44	0	9.6	16.6 / 8.3	6	15.25	5.75	5.87	3
3.0	85-3050SH	60	62	0	14.4	25.0 / 12.5	6	15.25	8.25	7.87	3
5.0	85-3055SH	60	89	0	24.0	41.6 / 20.8	6	15.25	8.25	7.87	3
7.5	85-3060SH	60	150	0	36	62 / 31	6	15.75	14.25	8.75	4
10	85-3065SH	60	165	0	48	83 / 41	6	15.75	14.25	8.75	4
15	61-3470SH	60	150	4	72	125 / 62	7	23.50	18.62	16.00	5
25	61-3475SH	60	232	4	120	208 / 104	7	23.50	18.62	16.00	5

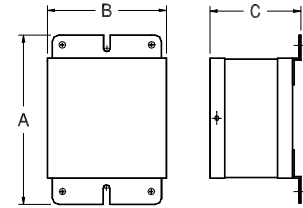

Outline Drawing 1
Wall Mount - Ventilated - NEMA 1

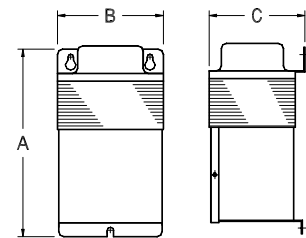

Outline Drawing 2
Wall Mount - Ventilated - NEMA 3R

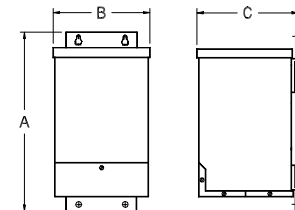

Outline Drawing 3
Wall Mount - Encapsulated - NEMA 3R
Note: 3 kVA & 5kVA 85 Series are also available in Outline Drawing 4 Configuration

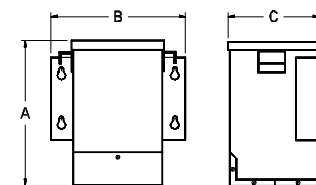

Outline Drawing 4
Wall Mount - Encapsulated - NEMA 3R

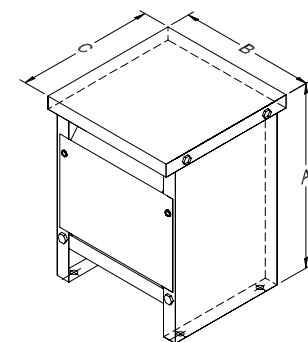

Outline Drawing 5
Floor Mount - Ventilated - NEMA 3R

Primary Volts 277, Secondary Volts 120 / 240

General Information				Winding Specifications				Dimensions			
kVA Cap.	Catalog Number	Hz.	Wgt. Lbs	Taps	Maximum Amps		Conn Dia. Pg. 16	Height A	Width B	Depth C	Outline Dwg.
					Pri.	Sec.					
.100	35-4010	50/60	5	0	.3	.8 / .4	8	6.37	3.75	3.37	1
.150	35-4015	50/60	7	0	.5	1.2 / .6	8	7.00	4.00	3.63	2
.250	85-4020SH	50/60	15	0	.9	2.0 / 1.0	9	12.00	4.87	5.25	3
.500	85-4025SH	50/60	18	0	1.8	4.1 / 2.0	9	12.00	4.87	5.25	3
.750	85-4030SH	50/60	22	0	2.7	6.2 / 3.1	9	12.00	4.87	5.25	3
1.0	85-4035SH	60	29	0	3.6	8.3 / 4.1	9	15.25	5.75	5.87	3
1.5	85-4040SH	60	37	0	5.4	12.5 / 6.2	9	15.25	5.75	5.87	3
2.0	85-4045SH	60	44	0	7.2	16.6 / 8.3	9	15.25	5.75	5.87	3
3.0	85-4050SH	60	62	0	10.8	25.0 / 12.5	9	15.25	8.25	7.87	3
5.0	85-4055SH	60	89	0	18	41.6 / 20.8	9	15.25	8.25	7.87	3
7.5	85-4060SH	60	150	0	27	62 / 31	9	15.75	14.25	8.75	4
10	85-4065SH	60	165	0	36	83 / 41	9	15.75	14.25	8.75	4
15	61-4470SH	60	150	4	54	125 / 62	10	23.50	18.62	16.00	5
25	61-4475SH	60	232	4	90	208 / 104	10	23.50	18.62	16.00	5

Connection Diagrams may be found on Pgs. 15 - 16

Tap Configurations:

- 0 = No Taps
- 2 = 1 - 5% FCAN, 1 - 5% FCBN
- 4 = 2 - 2½% FCAN, 2 - 2½% FCBN
- 6 = 2 - 2½% FCAN, 4 - 2½% FCBN

Dimensions & weights may change. Consult factory for certified drawings.

Primary Volts 600, Secondary Volts 120 / 240

General Information				Winding Specifications				Dimensions			
kVA Cap.	Catalog Number	Hz.	Wgt. Lbs	Taps	Maximum Amps		Conn Dia. Pg. 16	Height A	Width B	Depth C	Outline Dwg.
					Pri.	Sec.					
.100	35-5010	50/60	5	0	.1	.8 / .4	12	6.37	3.75	3.37	1
.150	35-5015	50/60	7	0	.2	1.2 / .6	12	7.00	4.00	3.63	2
.250	85-5020SH	50/60	15	0	.4	2.0 / 1.0	13	12	4.87	5.25	3
.500	85-5025SH	50/60	18	0	.8	4.1 / 2.0	13	12	4.87	5.25	3
.750	85-5030SH	50/60	22	0	1.2	6.2 / 3.1	13	12	4.87	5.25	3
1.0	85-5035SH	60	29	0	1.6	8.3 / 4.1	13	15.25	5.75	5.87	3
1.5	85-5040SH	60	37	0	2.5	12.5 / 6.2	13	15.25	5.75	5.87	3
2.0	85-5045SH	60	44	0	3.3	16.6 / 8.3	13	15.25	5.75	5.87	3
3.0	85-5050SH	60	62	0	5.0	25.0 / 12.5	13	15.25	8.25	7.87	3
5.0	85-5055SH	60	89	0	8.3	41.6 / 20.8	13	15.25	8.25	7.87	3
7.5	85-5060SH	60	150	0	12	62 / 31	13	15.75	14.25	8.75	4
10	85-5065SH	60	165	0	16	83 / 41	13	15.75	14.25	8.75	4
15	85-5470SH	60	150	4	25	125 / 62	14	19.38	17.56	11.50	4
25	85-5475SH	60	232	4	41.6	208 / 104	14	19.38	17.56	11.50	4
Cabinet Style											
15	61-5470SH	60	150	4	25	125 / 62	14	23.50	18.62	16.00	5
25	61-5475SH	60	232	4	41.6	208 / 104	14	23.50	18.62	16.00	5
37.5	61-5480SH	60	330	4	62	312 / 156	14	32.00	27.00	26.25	5
50	61-5485SH	60	359	4	83	416 / 208	14	32.00	27.00	26.25	5
75	61-5490SH	60	524	4	125	625 / 312	14	41.00	34.00	26.75	5
100	61-5495SH	60	648	4	166	833 / 416	14	41.00	34.00	26.75	5

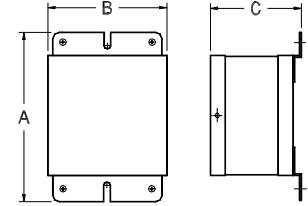

Outline Drawing 1
Wall Mount - Ventilated - NEMA 1

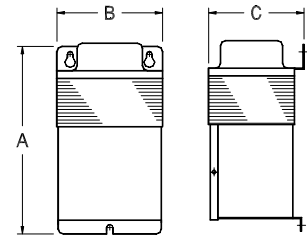

Outline Drawing 2
Wall Mount - Ventilated - NEMA 3R

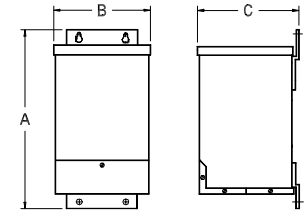

Outline Drawing 3
Wall Mount - Encapsulated - NEMA 3R
Note: 3 kVA & 5kVA 85 Series are also available in Outline Drawing 4 Configuration

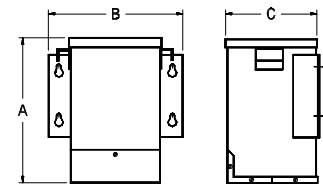

Outline Drawing 4
Wall Mount - Encapsulated - NEMA 3R

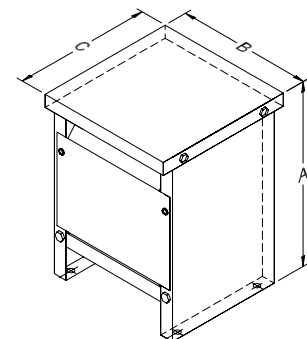

Outline Drawing 5
Floor Mount - Ventilated - NEMA 3R

Primary Volts 120 / 240, Secondary Volts 120 / 240

General Information				Winding Specifications				Dimensions			
kVA Cap.	Catalog Number	Hz.	Wgt. Lbs	Taps	Maximum Amps		Conn Dia. Pg. 17	Height A	Width B	Depth C	Outline Dwg.
					Pri.	Sec.					
.100	35-6010	50/60	5	0	.8 / .4	.8 / .4	15	6.37	3.75	3.37	1
.150	35-6015	50/60	7	0	1.2 / .6	1.2 / .6	15	7.00	4.00	3.63	2
.250	85-6020SH	50/60	15	0	2.0 / 1.0	2.0 / 1.0	16	12	4.87	5.25	3
.500	85-6025SH	50/60	18	0	4.1 / 2.0	4.1 / 2.0	16	12	4.87	5.25	3
.750	85-6030SH	50/60	22	0	6.2 / 3.1	6.2 / 3.1	16	12	4.87	5.25	3
1.0	85-6035SH	60	29	0	8.3 / 4.1	8.3 / 4.1	16	15.25	5.75	5.87	3
1.5	85-6040SH	60	37	0	12.5 / 6.2	12.5 / 6.2	16	15.25	5.75	5.87	3
2.0	85-6045SH	60	44	0	16.6 / 8.3	16.6 / 8.3	16	15.25	5.75	5.87	3
3.0	85-6050SH	60	62	0	25.0 / 12.5	25.0 / 12.5	16	15.25	8.25	7.87	3
5.0	85-6055SH	60	89	0	41.6 / 20.8	41.6 / 20.8	16	15.25	8.25	7.87	3
7.5	85-6060SH	60	150	0	62 / 31	62 / 31	16	15.75	14.25	8.75	4
10	85-6065SH	60	165	0	83 / 41	83 / 41	16	15.75	14.25	8.75	4
15	61-6470SH	60	150	4	125 / 62	125 / 62	17	23.50	18.62	16.00	5
25	61-6475SH	60	232	4	208 / 104	208 / 104	17	23.50	18.62	16.00	5

Connection Diagrams may be found on
Pgs. 16 - 17

Single Phase - Low Voltage

Primary Volts 120 X 240, Secondary Volts 12 / 24

General Information				Winding Specifications				Dimensions			
kVA Cap.	Catalog Number	Hz.	Wgt. Lbs	Taps	Maximum Amps		Conn Dia. Pg. 17	Height A	Width B	Depth C	Outline Dwg.
					Pri.	Sec.					
.050	35-M005	50/60	4	0	.4 / .2	4.1 / 2.0	18	6.37	3.75	3.37	1
.100	35-M010	50/60	5	0	.8 / .4	8.3 / 4.1	18	6.37	3.75	3.37	1
.150	35-M015	50/60	7	0	1.2 / .6	12.5 / 6.2	18	7.00	3.87	3.37	2
.250	85-M020	50/60	15	0	2.0 / 1.0	20.8 / 10.4	18	12.00	4.87	5.25	3
.500	85-M025	50/60	19	0	4.1 / 2.0	41.6 / 20.8	18	12.00	4.87	5.25	3
.750	85-M030	50/60	23	0	6.2 / 3.1	62.5 / 31.2	18	12.00	4.87	5.25	3
1.0	85-M035	60	28	0	8 / 4	83 / 41	18	15.25	5.75	5.87	3
1.5	85-M040	60	39	0	12 / 6	125 / 62	18	15.25	5.75	5.87	3
2.0	85-M045	60	43	0	16 / 8	166 / 83	18	15.25	5.75	5.87	3
3.0	85-M050	60	69	0	25 / 12	250 / 125	18	15.25	8.25	7.87	3
5.0	85-M055	60	89	0	41 / 20	416 / 208	18	15.25	8.25	7.87	3

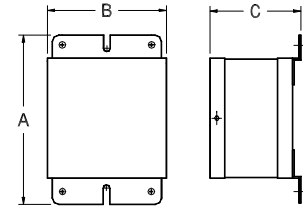

Outline Drawing 1
Wall Mount - Ventilated - NEMA 1

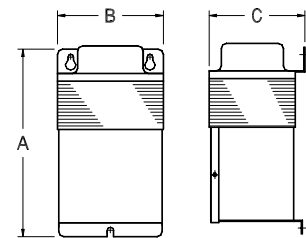

Outline Drawing 2
Wall Mount - Ventilated - NEMA 3R

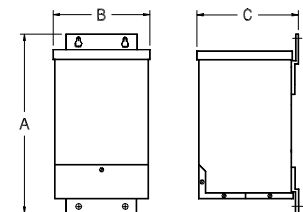

Outline Drawing 3
Wall Mount - Encapsulated - NEMA 3R
Note: 3 kVA & 5kVA 85 Series are also available in Outline Drawing 4 Configuration

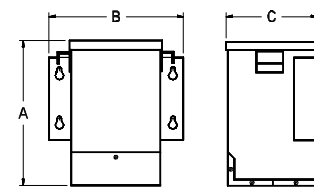

Outline Drawing 4
Wall Mount - Encapsulated - NEMA 3R

Primary Volts 120 X 240, Secondary Volts 16 / 32

General Information				Winding Specifications				Dimensions			
kVA Cap.	Catalog Number	Hz.	Wgt. Lbs	Taps	Maximum Amps		Conn Dia. Pg. 17	Height A	Width B	Depth C	Outline Dwg.
					Pri.	Sec.					
.050	35-Y005	50/60	4	0	.4 / .2	3.1 / 1.5	19	6.37	3.75	3.37	1
.100	35-Y010	50/60	5	0	.8 / .4	6.2 / 3.1	19	6.37	3.75	3.37	1
.150	35-Y015	50/60	7	0	1.2 / .6	9.3 / 4.6	19	7.00	4.00	3.63	2
.250	85-Y020	50/60	15	0	2.0 / 1.0	15.6 / 7.8	19	12.00	4.87	5.25	3
.500	85-Y025	50/60	19	0	4.1 / 2.0	31.2 / 15.6	19	12.00	4.87	5.25	3
.750	85-Y030	50/60	23	0	6.2 / 3.1	46.8 / 23.4	19	12.00	4.87	5.25	3
1.0	85-Y035	60	28	0	8 / 4	62 / 31	19	15.25	5.75	5.87	3
1.5	85-Y040	60	39	0	12 / 6	93 / 46	19	15.25	5.75	5.87	3
2.0	85-Y045	60	43	0	16 / 8	125 / 62	19	15.25	5.75	5.87	3
3.0	85-Y050	60	69	0	25 / 12	187 / 93	19	15.25	8.25	7.87	3
5.0	85-Y055	60	89	0	41 / 20	312 / 156	19	15.25	8.25	7.87	3

Primary Volts 240 X 480, Secondary Volts 24 / 48

General Information				Winding Specifications				Dimensions			
kVA Cap.	Catalog Number	Hz.	Wgt. Lbs	Taps	Maximum Amps		Conn Dia. Pg. 17	Height A	Width B	Depth C	Outline Dwg.
					Pri.	Sec.					
.100	35-LM010	50/60	5	0	.4 / .2	4.1 / 2.0	20	6.37	3.75	3.37	1
.150	35-LM015	50/60	7	0	.6 / .3	6.2 / 3.1	20	7.00	4.00	3.63	2
.250	85-LM020	50/60	15	0	1.0 / .52	10.4 / 5.2	20	12.00	4.87	5.25	3
.500	85-LM025	50/60	19	0	2.0 / 1.0	20.8 / 10.4	20	12.00	4.87	5.25	3
.750	85-LM030	50/60	23	0	3.1 / 1.6	31.2 / 15.6	20	12.00	4.87	5.25	3
1.0	85-LM035	60	28	0	4 / 2	41 / 20	20	15.25	5.75	5.87	3
1.5	85-LM040	60	39	0	6 / 3	62 / 31	20	15.25	5.75	5.87	3
2.0	85-LM045	60	43	0	8 / 4	83 / 41	20	15.25	5.75	5.87	3
3.0	85-LM050	60	69	0	12 / 6	125 / 62	20	15.25	8.25	7.87	3
5.0	85-LM055	60	89	0	20 / 10	208 / 104	20	15.25	8.25	7.87	3

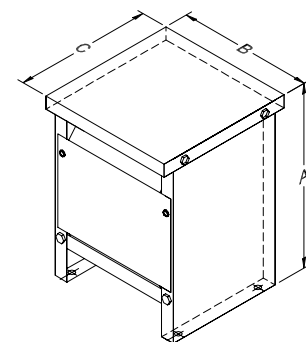

Outline Drawing 5
Floor Mount - Ventilated - NEMA 3R

Primary Volts 240 X 480, Secondary Volts 120 / 240

General Information				Winding Specifications				Dimensions			
kVA Cap.	Catalog Number	Hz.	Wgt. Lbs	Taps	Maximum Amps		Conn Dia. Pg. 15	Height A	Width B	Depth C	Outline Dwg.
					Pri.	Sec.					
.050	35-1005	50/60	3.3	0	.2 / .1	.4 / 2	1	6.37	3.75	3.37	1
.100	35-1010	50/60	5	0	.4 / .2	.8 / 4	1	6.37	3.75	3.37	1
.150	35-1015	50/60	7	0	.6 / .3	1.2 / .6	1	7.00	4.00	3.63	2
.250	35-1020	50/60	11	0	1.0 / .52	2.0 / 1.0	1	7.50	4.63	4.00	2
.500	35-1025	50/60	20	0	2.0 / 1.0	4.1 / 2.0	1	9.25	5.50	4.75	2
.750	35-1030	50/60	28	0	3.1 / 1.6	6.2 / 3.1	1	10.88	5.50	4.75	2
1.0	80-1035	50/60	29	0	4.1 / 2.0	8.3 / 4.1	1	10.88	5.50	4.75	2
1.5	80-1040	50/60	37	0	6.2 / 3.1	12.5 / 6.2	1	10.63	6.63	5.88	2
2.0	80-1045	60	41	0	8.3 / 4.1	16.6 / 8.3	1	11.00	6.63	5.88	2
3.0	80-1050	60	53	0	12.5 / 6.2	25.0 / 12.5	1	10.88	7.69	6.88	2
5.0	80-1055	60	77	0	20.8 / 10.4	41.6 / 20.8	1	13.69	7.69	6.88	2

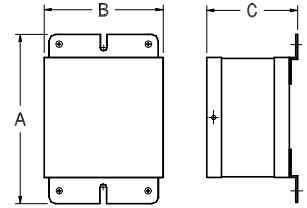

Outline Drawing 1
Wall Mount - Ventilated - NEMA 1

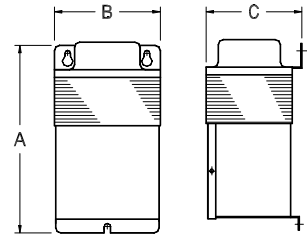

Outline Drawing 2
Wall Mount - Ventilated - NEMA 3R

Primary Volts 208, Secondary Volts 120 / 240

General Information				Winding Specifications				Dimensions			
kVA Cap.	Catalog Number	Hz.	Wgt. Lbs	Taps	Maximum Amps		Conn Dia. Pg. 15	Height A	Width B	Depth C	Outline Dwg.
					Pri.	Sec.					
.100	35-3010	50/60	5	0	.4	.8 / 4	5	6.37	3.75	3.37	1
.150	35-3015	50/60	7	0	.7	1.2 / .6	5	7.00	4.00	3.63	2
.250	35-3020	50/60	11	0	1.2	2.0 / 1.0	5	7.50	4.63	4.00	2
.500	35-3025	50/60	20	0	2.4	4.1 / 2.0	5	9.25	5.50	4.75	2
.750	35-3030	50/60	28	0	3.6	6.2 / 3.1	5	10.88	5.50	4.75	2
1.0	80-3035	50/60	29	0	4.8	8.3 / 4.1	5	10.88	5.50	4.75	2
1.5	80-3040	50/60	37	0	7.2	12.5 / 6.2	5	10.63	6.63	5.88	2

Connection Diagrams may be found on Pgs. 15 - 16

Tap Configurations:

- 0 = No Taps
- 2 = 1 - 5% FCAN, 1 - 5% FCBN
- 4 = 2 - 2½% FCAN, 2 - 2½% FCBN
- 6 = 2 - 2½% FCAN, 4 - 2½% FCBN

Dimensions & weights may change. Consult factory for certified drawings.

Primary Volts 277, Secondary Volts 120 / 240

General Information				Winding Specifications				Dimensions			
kVA Cap.	Catalog Number	Hz.	Wgt. Lbs	Taps	Maximum Amps		Conn Dia. Pg. 16	Height A	Width B	Depth C	Outline Dwg.
					Pri.	Sec.					
.100	35-4010	50/60	5	0	.3	.8 / 4	8	6.37	3.75	3.37	1
.150	35-4015	50/60	7	0	.5	1.2 / .6	8	7.00	4.00	3.63	2
.250	35-4020	50/60	11	0	.9	2.0 / 1.0	8	7.50	4.63	4.0	2
.500	35-4025	50/60	20	0	1.8	4.1 / 2.0	8	9.25	5.50	4.75	2
.750	35-4030	50/60	28	0	2.7	6.2 / 3.1	8	10.88	5.50	4.75	2
1.0	80-4035	50/60	29	0	3.6	8.3 / 4.1	8	10.88	5.50	4.75	2
1.5	80-4040	50/60	37	0	5.4	12.5 / 6.2	8	10.63	6.63	5.88	2

Single Phase - General Purpose Ventilated

**Primary Volts 600,
Secondary Volts 120 / 240**

General Information				Winding Specifications				Dimensions			
kVA Cap.	Catalog Number	Hz.	Wgt. Lbs	Taps	Maximum Amps		Conn Dia. Pg. 16	Height A	Width B	Depth C	Outline Dwg.
					Pri.	Sec.					
.100	35-5010	50/60	5	0	.1	.8 / .4	12	6.37	3.75	3.37	1
.150	35-5015	50/60	7	0	.2	1.2 / .6	12	7.00	4.00	3.63	2
.250	35-5020	50/60	11	0	.4	2.0 / 1.0	12	7.50	4.63	4.00	2
.500	35-5025	50/60	20	0	.8	4.1 / 2.0	12	9.25	5.50	4.75	2
.750	35-5030	50/60	28	0	1.2	6.2 / 3.1	12	10.88	5.50	4.75	2
1.0	80-5035	50/60	29	0	1.6	8.3 / 4.1	12	10.88	5.50	4.75	2
1.5	80-5040	50/60	37	0	2.5	12.5 / 6.2	12	10.63	6.63	5.88	2

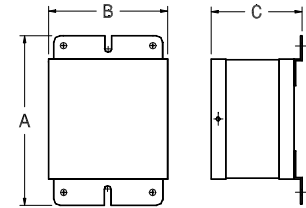

Outline Drawing 1
Wall Mount - Ventilated - NEMA 1

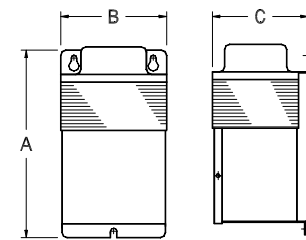

Outline Drawing 2
Wall Mount - Ventilated - NEMA 3R

**Primary Volts 120 / 240,
Secondary Volts 120 / 240**

General Information				Winding Specifications				Dimensions			
kVA Cap.	Catalog Number	Hz.	Wgt. Lbs	Taps	Maximum Amps		Conn Dia. Pg. 17	Height A	Width B	Depth C	Outline Dwg.
					Pri.	Sec.					
.100	35-6010	50/60	5	0	.8 / .4	.8 / .4	15	6.37	3.75	3.37	1
.150	35-6015	50/60	7	0	1.2 / .6	1.2 / .6	15	7.00	4.00	3.63	2
.250	35-6020	50/60	11	0	2.0 / 1.0	2.0 / 1.0	15	7.50	4.63	4.00	2
.500	35-6025	50/60	20	0	4.1 / 2.0	4.1 / 2.0	15	9.25	5.50	4.75	2
.750	35-6030	50/60	28	0	6.2 / 3.1	6.2 / 3.1	15	10.88	5.50	4.75	2
1.0	80-6035	50/60	29	0	8.3 / 4.1	8.3 / 4.1	15	10.88	5.50	4.75	2
1.5	80-6040	50/60	37	0	12.5 / 6.2	12.5 / 6.2	15	10.63	6.63	5.88	2

**Primary Volts 480,
Secondary Volts 120 / 240,
With 2 - 5% FCBN Taps**

General Information				Winding Specifications				Dimensions			
kVA Cap.	Catalog Number	Hz.	Wgt. Lbs	Tap Code	Maximum Amps		Conn Dia.	Height A	Width B	Depth C	Outline Dwg.
					Pri.	Sec.					
1.0	80-7235	50/60	29	*	2.0	8.3 / 4.1	See Wind. Dia. at Right	10.88	5.50	4.75	2
1.5	80-7240	50/60	37	*	3.1	12.5 / 6.2		10.63	6.63	5.88	2
2.0	80-7245	60	41	*	4.1	16.6 / 8.3		11.00	6.63	5.88	2
3.0	80-7250	60	53	*	6.2	25.0 / 12.5		10.88	7.69	6.88	2
5.0	80-7255	60	77	*	10.4	41.6 / 20.8		13.69	7.69	6.88	2

* Tap Configuration for this series is: 2 - 5% FCBN

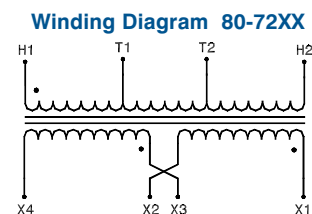

Primary Volts 120 X 240, Secondary Volts 12 / 24

General Information				Winding Specifications			Dimensions				
kVA Cap.	Catalog Number	Hz.	Wgt. Lbs	Taps	Maximum Amps		Conn Dia. Pg. 17	Height A	Width B	Depth C	Outline Dwg.
					Pri.	Sec.					
.050	35-M005	50/60	5	0	.4 / .2	4.1 / 2.0	18	6.37	3.75	3.37	1
.100	35-M010	50/60	8	0	.8 / .4	8.3 / 4.1	18	6.37	3.75	3.37	1
.150	35-M015	50/60	8	0	1.2 / .6	12.5 / 6.2	18	7.00	4.00	3.63	2
.250	35-M020	50/60	11	0	2.0 / 1.0	20.8 / 10.4	18	7.50	4.63	4.00	2
.500	35-M025	50/60	20	0	4.1 / 2.0	41.6 / 20.8	18	9.28	5.50	4.75	2
.750	35-M030	50/60	28	0	6.2 / 3.1	62.5 / 31.2	18	10.88	5.50	4.75	2
1.0	80-M035	50/60	29	0	8 / 4	83 / 41	18	10.88	5.50	4.75	2
1.5	80-M040	50/60	37	0	12 / 6	125 / 62	18	10.63	6.63	5.88	2
2.0	80-M045	60	42	0	16 / 8	166 / 83	18	11.00	6.63	5.88	2
3.0	80-M050	60	58	0	25 / 12	250 / 125	18	16.38	7.69	6.88	2
5.0	80-M055	60	82	0	41 / 20	416 / 208	18	18.50	7.69	6.88	2

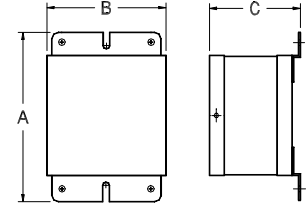

Outline Drawing 1
Wall Mount - Ventilated - NEMA 1

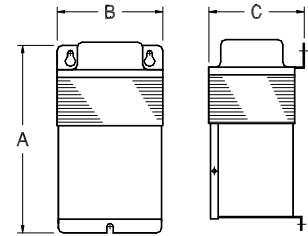

Outline Drawing 2
Wall Mount - Ventilated - NEMA 3R

Primary Volts 120 X 240, Secondary Volts 16 / 32

General Information				Winding Specifications			Dimensions				
kVA Cap.	Catalog Number	Hz.	Wgt. Lbs	Taps	Maximum Amps		Conn Dia. Pg. 17	Height A	Width B	Depth C	Outline Dwg.
					Pri.	Sec.					
.050	35-Y005	50/60	5	0	.4 / .2	3.1 / 1.5	19	6.37	3.75	3.37	1
.100	35-Y010	50/60	8	0	.8 / .4	6.2 / 3.1	19	6.37	3.75	3.37	1
.150	35-Y015	50/60	8	0	1.2 / .6	9.3 / 4.6	19	7.00	4.00	3.63	2
.250	35-Y020	50/60	11	0	2.0 / 1.0	15.6 / 7.8	19	7.50	4.63	4.00	2
.500	35-Y025	50/60	20	0	4.1 / 2.0	31.2 / 15.6	19	9.25	5.50	4.75	2
.750	35-Y030	50/60	28	0	6.2 / 3.1	46.8 / 23.4	19	10.88	5.50	4.75	2
1.0	80-Y035	50/60	29	0	8 / 4	62 / 31	19	10.88	5.50	4.75	2
1.5	80-Y040	50/60	37	0	12 / 6	93 / 46	19	10.63	6.63	5.88	2
2.0	80-Y045	60	42	0	16 / 8	125 / 62	19	11.00	6.63	5.88	2
3.0	80-Y050	60	58	0	25 / 12	187 / 93	19	16.38	7.69	6.88	2
5.0	80-Y055	60	82	0	41 / 20	312 / 156	19	18.50	7.69	6.88	2

Connection Diagrams may be found on Pgs. 17

Tap Configurations:

- 0 = No Taps
- 2 = 1 - 5% FCAN, 1 - 5% FCBN
- 4 = 2 - 2½% FCAN, 2 - 2½% FCBN
- 6 = 2 - 2½% FCAN, 4 - 2½% FCBN

Dimensions & weights may change. Consult factory for certified drawings.

Primary Volts 240 X 480, Secondary Volts 24 / 48

General Information				Windings Specifications			Dimensions				
kVA Cap.	Catalog Number	Hz.	Wgt. Lbs	Taps	Maximum Amps		Conn Dia. Pg. 17	Height A	Width B	Depth C	Outline Dwg.
					Pri.	Sec.					
.100	35-LM010	50/60	8	0	.4 / .2	4.1 / 2.0	20	6.37	3.75	3.37	1
.150	35-LM015	50/60	8	0	.6 / .3	6.2 / 3.1	20	7.00	4.00	3.63	2
.250	35-LM020	50/60	11	0	1.0 / .52	10.4 / 5.2	20	7.50	4.63	4.00	2
.500	35-LM025	50/60	20	0	2.0 / 1.0	20.8 / 10.4	20	9.25	5.50	4.75	2
.750	35-LM030	50/60	28	0	3.1 / 1.6	31.2 / 15.6	20	10.88	5.50	4.75	2
1.0	80-LM035	50/60	29	0	4 / 2	41 / 20	20	10.88	5.50	4.75	2
1.5	80-LM040	50/60	37	0	6 / 3	62 / 31	20	10.63	6.63	5.88	2
2.0	80-LM045	60	42	0	8 / 4	83 / 41	20	11.00	6.63	5.88	2
3.0	80-LM050	60	58	0	12 / 6	125 / 62	20	16.38	7.69	6.88	2
5.0	80-LM055	60	82	0	20 / 10	208 / 104	20	18.50	7.69	6.88	2

Single Phase Connection Diagrams

Dia. 1 Catalog Series 35-10XX & 80-10XX			
Tap Arrangement	None		
% High Voltage	High Voltage 240 X 480	Inter-Connect	Connect High Voltage Lines To
100	240	H1 To H3 H2 To H4	H1H3 & H2H4
100	480	H2 To H3	H1 & H4
% Low Voltage	Low Voltage 120 / 240	Inter-Connect	Connect Low Voltage Lines To
100	120	X1 To X3 X2 To X4	X1X3 & X2X4
100	120 / 240	X2 To X3	X1 & X2X3 & X4
100	240	X2 To X3	X1 & X4

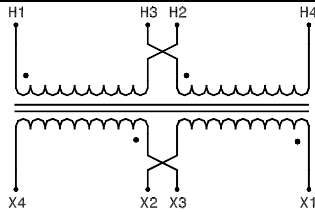

Dia. 2 Catalog Series 85-14XXSH & 61-14XXSH				
Tap Arrangement	2 - 2½ FCAN (Full Capacity Above Normal) 2 - 2½ FCBN (Full Capacity Below Normal)			
% High Voltage	High Voltage 240 X 480	Inter-Connect	Connect High Voltage Lines To	
105	252	H1 To 2 H2 To 1	H1 & H2	
100	240	H1 To 4 H2 To 3		
95	228	H1 To 6 H2 To 5		
105	504	1 To 2		
102.5	492	2 To 3		
100	480	3 To 4		
97.5	468	4 To 5		
95	456	5 To 6		
% Low Voltage	Low Voltage 120 / 240	Inter-Connect		Connect Low Voltage Lines To
100	120	X1 To X3 X2 To X4		X1X3 & X2X4
100	120 / 240	X2 To X3	X1 & X2X3 & X4	
100	240	X2 To X3	X1 & X4	

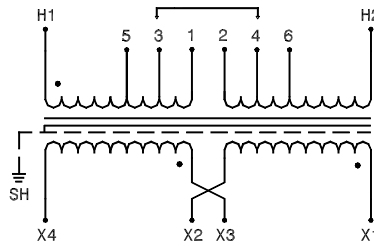

Dia. 3 Catalog Series 61-16XXSH			
Tap Arrangement	2 - 2½ FCAN (Full Capacity Above Normal) 4 - 2½ FCBN (Full Capacity Below Normal)		
% High Voltage	High Voltage 240 X 480	Inter-Connect	Connect High Voltage Lines To
105	252	H1 To 2 H2 To 1	H1 & H2
100	240	H1 To 4 H2 To 3	
95	228	H1 To 6 H2 To 5	
90	216	H1 To 8 H2 To 7	
105	504	1 To 2	
102.5	492	2 To 3	
100	480	3 To 4	
97.5	468	4 To 5	
95	456	5 To 6	
92.5	444	6 To 7	
90	432	7 To 8	
% Low Voltage	Low Voltage 120 / 240	Inter-Connect	Connect Low Voltage Lines To
100	120	X1 To X3 X2 To X4	X1X3 & X2X4
100	120 / 240	X2 To X3	X1 & X2X3 & X4
100	240	X2 To X3	X1 & X4

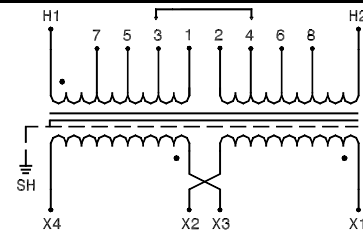

Dia. 4 Catalog Series 85-10XXSH			
Tap Arrangement	None		
% High Voltage	High Voltage 240 X 480	Inter-Connect	Connect High Voltage Lines To
100	240	H1 To H3 H2 To H4	H1H3 & H2H4
100	480	H2 To H3	H1 & H4
% Low Voltage	Low Voltage 120 / 240	Inter-Connect	Connect Low Voltage Lines To
100	120	X1 To X3 X2 To X4	X1X3 & X2X4
100	120 / 240	X2 To X3	X1 & X2X3 & X4
100	240	X2 To X3	X1 & X4

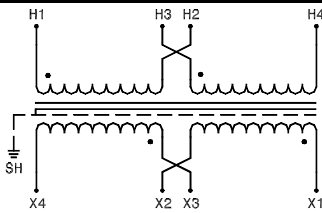

Dia. 5 Catalog Series 35-30XX & 80-30XX			
Tap Arrangement	None		
% High Voltage	High Voltage 208	Inter-Connect	Connect High Voltage Lines To
100	208	--	H1 & H2
% Low Voltage	Low Voltage 120 / 240	Inter-Connect	Connect Low Voltage Lines To
100	120	X1 To X3 X2 To X4	X1X3 & X2X4
100	120 / 240	X2 To X3	X1 & X2X3 & X4
100	240	X2 To X3	X1 & X4

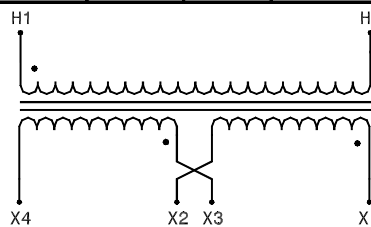

Dia. 6 Catalog Series 85-30XXSH			
Tap Arrangement	None		
% High Voltage	High Voltage 208	Inter-Connect	Connect High Voltage Lines To
100	208	--	H1 & H2
% Low Voltage	Low Voltage 120 / 240	Inter-Connect	Connect Low Voltage Lines To
100	120	X1 To X3 X2 To X4	X1X3 & X2X4
100	120 / 240	X2 To X3	X1 & X2X3 & X4
100	240	X2 To X3	X1 & X4

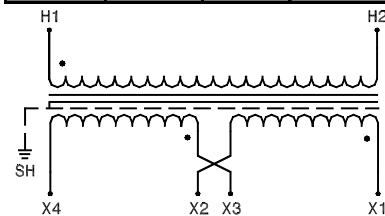

Dia. 7 Catalog Series 61-34XXSH			
Tap Arrangement	2-2½ % FCAN (Full Capacity Above Normal) 2-2½ % FCBN (Full Capacity Below Normal)		
% High Voltage	High Voltage 208	Inter-Connect	Connect High Voltage Lines To
105	218	1 To 2	H1 & H2
102.5	213	2 To 3	
100	208	3 To 4	
97.5	203	4 To 5	
95	198	5 To 6	
% Low Voltage	Low Voltage 120 / 240	Inter-Connect	
100	120	X1 To X3 X2 To X4	X1X3 & X2X4
100	120 / 240	X2 To X3	X1 & X2X3 & X4
100	240	X2 To X3	X1 & X4

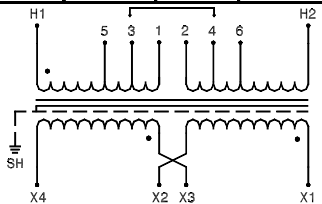

DONGAN ELECTRIC MANUFACTURING CO. • 2987 FRANKLIN • DETROIT, MI 48207
 800.428.2626 • 313.567.8500 • FAX 313.567.8828 • www.dongan.com

Single Phase Connection Diagrams

DONGAN ELECTRIC MANUFACTURING CO. • 2987 FRANKLIN • DETROIT, MI 48207
 800.428.2626 • 313.567.8500 • FAX 313.567.8828 • www.dongan.com

Dia. 8 Catalog Series 35-40XX & 80-40XX			
Tap Arrangement	None		
% High Voltage	High Voltage 277	Inter-Connect	Connect High Voltage Lines To
100	277	--	H1 & H2
% Low Voltage	Low Voltage 120 / 240	Inter-Connect	Connect Low Voltage Lines To
100	120	X1 To X3 X2 To X4	X1X3 & X2X4
100	120 / 240	X2 To X3	X1 & X2X3 & X4
100	240	X2 To X3	X1 & X4

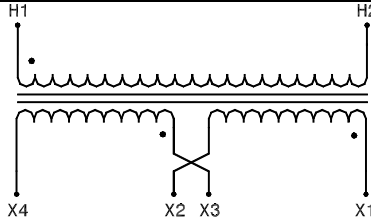

Dia. 9 Catalog Series 85-40XXSH			
Tap Arrangement	None		
% High Voltage	High Voltage 277	Inter-Connect	Connect High Voltage Lines To
100	277	--	H1 & H2
% Low Voltage	Low Voltage 120 / 240	Inter-Connect	Connect Low Voltage Lines To
100	120	X1 To X3 X2 To X4	X1X3 & X2X4
100	120 / 240	X2 To X3	X1 & X2X3 & X4
100	240	X2 To X3	X1 & X4

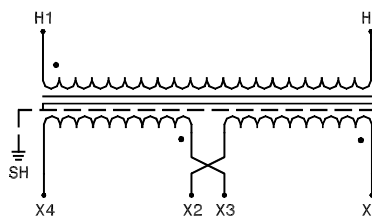

Dia. 10 Catalog Series 61-44XXSH			
Tap Arrangement	2-2½ % FCAN Full Capacity Above Normal) 2-2½ % FCBN Full Capacity Below Normal)		
% High Voltage	High Voltage 277	Inter-Connect	Connect High Voltage Lines To
105	291	1 To 2	H1 & H2
102.5	284	2 To 3	
100	277	3 To 4	
97.5	270	4 To 5	
95	263	5 To 6	
% Low Voltage	Low Voltage 120 / 240	Inter-Connect	
100	120	X1 To X3 X2 To X4	X1X3 & X2X4
100	120 / 240	X2 To X3	X1 & X2X3 & X4
100	240	X2 To X3	X1 & X4

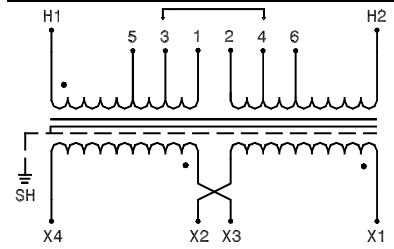

Dia. 11 Catalog Series 35-20XX & 80-20XX			
Tap Arrangement	None		
% High Voltage	High Voltage 240 X 480	Inter-Connect	Connect High Voltage Lines To
100	240	H1 To H3 H2 To H4	H1H3 & H2H4
100	480	H2 To H3	H1 & H4
% Low Voltage	Low Voltage 120 Fused	Inter-Connect	Connect Low Voltage Lines To
100	120	-	X1 & X2

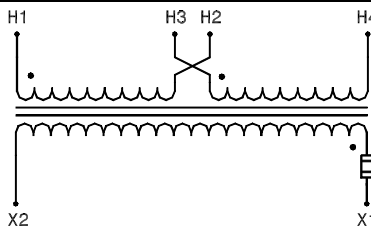

Dia. 12 Catalog Series 35-50XX & 80-50XX			
Tap Arrangement	None		
% High Voltage	High Voltage 600	Inter-Connect	Connect High Voltage Lines To
100	600	--	H1 & H2
% Low Voltage	Low Voltage 120 / 240	Inter-Connect	Connect Low Voltage Lines To
100	120	X1 To X3 X2 To X4	X1X3 & X2X4
100	120 / 240	X2 To X3	X1 & X2X3 & X4
100	240	X2 To X3	X1 & X4

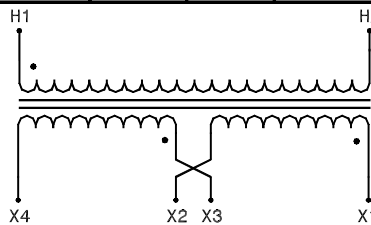

Dia. 13 Catalog Series 85-50XXSH			
Tap Arrangement	None		
% High Voltage	High Voltage 600	Inter-Connect	Connect High Voltage Lines To
100	600	--	H1 & H2
% Low Voltage	Low Voltage 120 / 240	Inter-Connect	Connect Low Voltage Lines To
100	120	X1 To X3 X2 To X4	X1X3 & X2X4
100	120 / 240	X2 To X3	X1 & X2X3 & X4
100	240	X2 To X3	X1 & X4

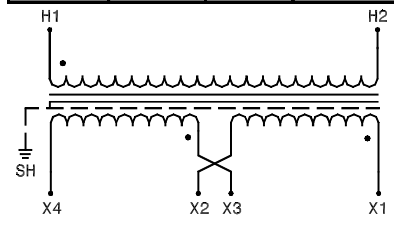

Dia. 14 Catalog Series 61-54XXSH			
Tap Arrangement	2-2½ % FCAN Full Capacity Above Normal) 2-2½ % FCBN Full Capacity Below Normal)		
% High Voltage	High Voltage 600	Inter-Connect	Connect High Voltage Lines To
105	630	1 To 2	H1 & H2
102.5	615	2 To 3	
100	600	3 To 4	
97.5	585	4 To 5	
95	570	5 To 6	
% Low Voltage	Low Voltage 120 / 240	Inter-Connect	
100	120	X1 To X3 X2 To X4	X1X3 & X2X4
100	120 / 240	X2 To X3	X1 & X2X3 & X4
100	240	X2 To X3	X1 & X4

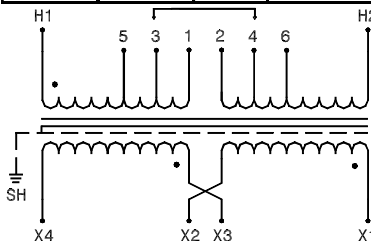

Single Phase Connection Diagrams

Dia. 15 Catalog Series 35-60XX & 80-60XX				
Tap Arrangement	None			
% High Voltage	High Voltage 120 X 240	Inter-Connect	Connect High Voltage Lines To	
100	120	H1 To H3 H2 To H4	H1H3 & H2H4	
100	240	H2 To H3	H1 & H4	
% Low Voltage	Low Voltage 120 / 240	Inter-Connect	Connect Low Voltage Lines To	
100	120	X1 To X3 X2 To X4	X1X3 & X2X4	
100	120 / 240	X2 To X3	X1 & X2X3 & X4	
100	240	X2 To X3	X1 & X4	

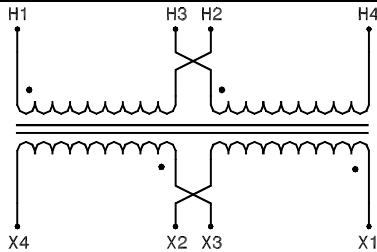

Dia. 16 Catalog Series 85-60XXSH				
Tap Arrangement	None			
% High Voltage	High Voltage 120 X 240	Inter-Connect	Connect High Voltage Lines To	
100	120	H1 To H3 H2 To H4	H1H3 & H2H4	
100	240	H2 To H3	H1 & H4	
% Low Voltage	Low Voltage 120 / 240	Inter-Connect	Connect Low Voltage Lines To	
100	120	X1 To X3 X2 To X4	X1X3 & X2X4	
100	120 / 240	X2 To X3	X1 & X2X3 & X4	
100	240	X2 To X3	X1 & X4	

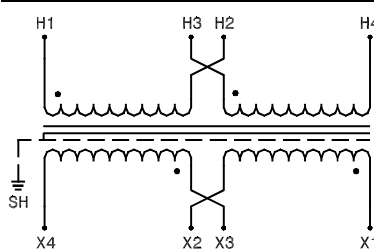

Dia. 17 Catalog Series 61-64XXSH				
Tap Arrangement	2 - 2½ FCAN (Full Capacity Above Normal) 2 - 2½ FCBN (Full Capacity Below Normal)			
% High Voltage	High Voltage 120 X 240	Inter-Connect	Connect High Voltage Lines To	
105	126	H1 To 2 H2 To 1	H1 & H2	
100	120	H1 To 4 H2 To 3		
95	114	H1 To 6 H2 To 5		
105	252	1 To 2		
102.5	246	2 To 3		
100	240	3 To 4		
97.5	234	4 To 5		
95	228	5 To 6		
% Low Voltage	Low Voltage 120 / 240	Inter-Connect	Connect Low Voltage Lines To	
100	120	X1 To X3 X2 To X4	X1X3 & X2X4	
100	120 / 240	X2 To X3	X1 & X2X3 & X4	
100	240	X2 To X3	X1 & X4	

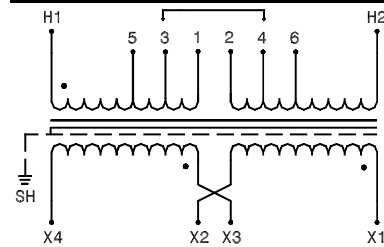

Dia. 18 Catalog Series 35-M0XX & 80-M0XX 85-M0XX				
Tap Arrangement	No Taps			
% High Voltage	High Voltage 120 X 240	Inter-Connect	Connect High Voltage Lines To	
100	120	H1 To H3 H2 To H4	H1H3 & H2H4	
100	240	H2 To H3	H1 & H4	
% Low Voltage	Low Voltage 12 / 24	Inter-Connect	Connect Low Voltage Lines To	
100	12	X1 To X3 X2 To X4	X1X3 & X2X4	
100	12 / 24	X2 To X3	X1 & X2X3 & X4	
100	24	X2 To X3	X1 & X4	

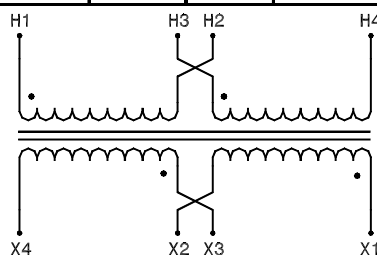

Dia. 19 Catalog Series 35-Y0XX & 80-Y0XX 85-Y0XX				
Tap Arrangement	No Taps			
% High Voltage	High Voltage 120 X 240	Inter-Connect	Connect High Voltage Lines To	
100	120	H1 To H3 H2 To H4	H1H3 & H2H4	
100	240	H2 To H3	H1 & H4	
% Low Voltage	Low Voltage 16 / 32	Inter-Connect	Connect Low Voltage Lines To	
100	16	X1 To X3 X2 To X4	X1X3 & X2X4	
100	16 / 32	X2 To X3	X1 & X2X3 & X4	
100	32	X2 To X3	X1 & X4	

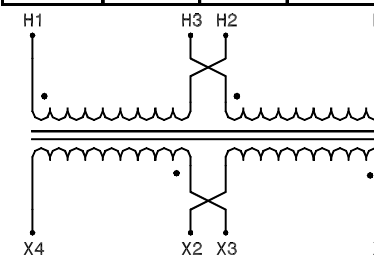

Dia. 20 Catalog Series 35-LM0XX & 80-LM0XX 85-LM0XX				
Tap Arrangement	No Taps			
% High Voltage	High Voltage 240 X 480	Inter-Connect	Connect High Voltage Lines To	
100	240	H1 To H3 H2 To H4	H1H3 & H2H4	
100	480	H2 To H3	H1 & H4	
% Low Voltage	Low Voltage 24 / 48	Inter-Connect	Connect Low Voltage Lines To	
100	24	X1 To X3 X2 To X4	X1X3 & X2X4	
100	24 / 48	X2 To X3	X1 & X2X3 & X4	
100	48	X2 To X3	X1 & X4	

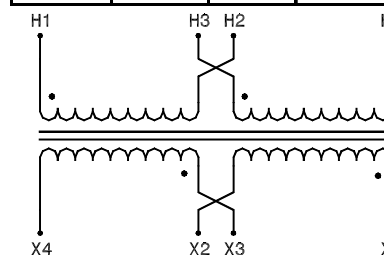

DONGAN ELECTRIC MANUFACTURING CO. • 2987 FRANKLIN • DETROIT, MI 48207
 800.428.2626 • 313.567.8500 • FAX 313.567.8828 • www.dongan.com